

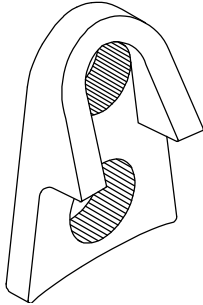

4499 RESTRAINT LUG

CAST DUCTILE IRON
PRICE INFORMATION



SIZES AVAILABLE:
One Size only.

USE:
ROBAR 4499 Restraint Lugs are designed for use on Mechanical Joint Fittings to prevent pipe pull-out.

Material: Cast Ductile Iron (ASTM A536)

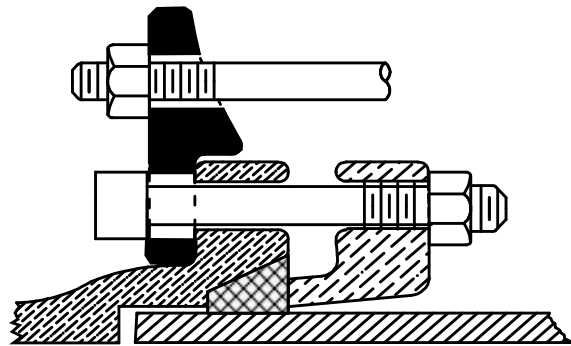

Robar Product No.	LIST PRICE
4499	\$ 12.46

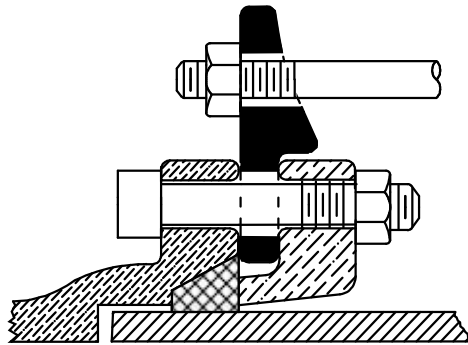

ROBAR INDUSTRIES LTD.

BC Phone (604) 591-8811 / 1-800-663-6553
Fax (604) 591-5288
Email: waterworks@robarindustries.com

LES PRODUITS INDUSTRIELS ROBAR INC.

QUEBEC Phone (450) 441-7525 / 1-800-315-9525
Fax (450) 441-4894
Web: www.Robarindustries.com