

1406 CAST DUCTILE IRON COUPLINGS

STRAIGHT & TRANSITION
PRICE INFORMATION

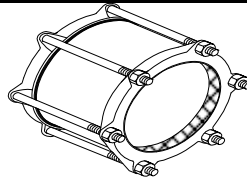

Nom Pipe Size	First End				By X	Second End				MAX. Press. (LBS/IN)	Fasteners No. Dia x Length	Sleeve Length (IN.)	List Price
	Range					Range							
	Low	Pipe OD Actual	High*	End Code		Low	Pipe OD Actual	High*	End Code				
2	2.35	2.38	2.63	D3	x	2.35	2.38	2.63	D3	300	2 5/8 x 8	5	\$94.26
2.5	2.69	2.88	2.9	D3	x	2.69	2.88	2.9	D3	300	2 5/8 x 8	5	\$102.32
4	3.45	3.50	3.60	4T	x	3.45	3.50	3.60	4T	300	4 5/8 x 8	5	\$175.38
	3.75		4.05	F3A		3.75		4.05	F3A				
	4.05		4.35	F3B		4.05		4.35	F3B		4 5/8 x 11	7	\$202.11
	4.40	4.50	4.60	D3		4.40	4.50	4.60	D3				
	4.74	4.80	5.10	A1		4.74	4.80	5.10	A1		4 5/8 x 14	10	\$242.15
	5.10		5.30	E5		5.10		5.30	E5				
6	5.85		6.15	F3A	x	5.85		6.15	F3A	300	5 5/8 x 8	5	\$242.14
	6.15		6.45	F3B		6.15		6.45	F3B				
	6.50	6.63	6.70	D3		6.50	6.63	6.70	D3		5 5/8 x 11	7	\$273.37
	6.86	6.90	7.10	A1		6.86	6.90	7.10	A1				
	7.15		7.35	E5		7.15		7.35	E5		5 - 5/8 x 14	10	\$326.78
8	7.90		8.25	F3A	x	7.90		8.25	F3A	300	6 5/8 x 8	5	\$304.01
	8.25		8.55	F3B		8.25		8.55	F3B				
	8.55	8.63	8.75	D3		8.55	8.63	8.75	D3		6 5/8 x 11	7	\$344.28
	8.99	9.05	9.30	A1		8.99	9.05	9.30	A1				
	9.30		9.50	E5		9.30		9.50	E5		6 - 5/8 x 14	10	\$424.40
10**	9.85		10.20	F4A	x	9.85		10.20	F4A	300	7 5/8 x 11	7	\$508.16
	10.20		10.50	F4B		10.20		10.50	F4B				
	10.60	10.75	10.90	D4		10.60	10.75	10.90	D4				
	11.10	11.10	11.40	B2		11.10	11.10	11.40	B2		7 5/8 x 14	10***	\$608.00
	11.55		11.75	A1		11.55		11.75	A1				
	11.90		12.10	E5		11.90		12.10	E5				
Series 2 (STANDARD STEEL AND DUCTILE SIZES ONLY)													
10	10.60	10.75	10.90	S9	x	10.60	10.75	10.90	S9	300	7 5/8 x 11	7	\$439.68
	11.10	11.10	11.40	G8		11.10	11.10	11.40	G8				

All dimensions are in inches

Continued....

Note: * The high limit of the range is used in the ordering code.
 ** Some transitions may required a stepped center sleeve.
 *** Only available with end codes B2, A1 & E5

ROBAR INDUSTRIES LTD.

BC Phone (604) 591-8811 / 1-800-663-6553
 Fax (604) 591-5288
 Email: waterworks@robarindustries.com

LES PRODUITS INDUSTRIELS ROBAR INC.

QUEBEC Phone (450) 441-7525 / 1-800-315-9525
 Fax (450) 441-4894
 Web: www.Robarindustries.com

1406 CAST DUCTILE IRON COUPLINGS

STRAIGHT AND TRANSITION

PRICE INFORMATION

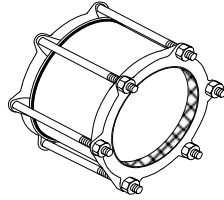

Nom Pipe Size	FIRST END				By X	SECOND END				MAX. Press (LBS/IN)	Fasteners No. Dia x Length	Sleeve Length (IN.)	List Price
	RANGE					RANGE							
	Low	Pipe OD Actual	High*	End Code		Low	Pipe OD Actual	High*	End Code				
12**	12.00		12.30	F4A	x	12.00		12.30	F4A	300	8 5/8 x 11	7	\$ 579.08
	12.30		12.60	F4B		12.30		12.60	F4B				
	12.60	12.75	12.90	D4		12.60	12.75	12.90	D4				
	13.20	13.20	13.60	B2		13.20	13.20	13.60	B2		8 5/8 x 14	10***	\$ 699.51
	13.80	14.00	14.10	A1		13.80	14.00	14.10	A1				
	14.10		14.35	E5		14.10		14.35	E5				
Series 2 (STANDARD STEEL AND DUCTILE SIZES ONLY)													
12	12.60	12.75	12.90	S9	x	12.60	12.75	12.90	S9	300	8 5/8 x 11	7	\$ 526.01
	13.20	13.20	13.50	G8		13.20	13.20	13.50	G8				
14	14.60		14.90	F2	x	14.60		14.90	F2	150	9 5/8 x 11	7	\$ 951.45
	15.30	15.30	15.70	B2		15.30	15.30	15.70	B2				
	15.80	16.00	16.25	A1		15.80	16.00	16.25	A1				
	16.40		16.80	E5		16.40		16.80	E5				
16	17.40	17.40	17.80	B2	x	17.40	17.40	17.80	B2	150	10 5/8 x 11	7	\$ 1,073.13
	17.80	18.00	18.20	A1		17.80	18.00	18.20	A1				
	18.40		18.80	E5		18.40		18.80	E5				
18	18.80		19.20	B1	x	18.80		19.20	B1	150	12 5/8 x 11	7	\$ 1,391.01
	19.10	19.50	19.70	A2		19.10	19.50	19.70	A2				
	19.70	20.00	20.25	E5		19.70	20.00	20.25	E5				
20	20.80		21.35	B1	x	20.80		21.35	B1	150	12 5/8 x 11	7	\$ 1,671.02
	21.35	21.60	21.75	A2		21.35	21.60	21.75	A2				
	21.75	22.00	22.25	E5		21.75	22.00	22.25	E5				
22	22.95		23.35	B1	x	22.95		23.35	B1	150	13 5/8 x 11	7	\$ 1,845.61
	23.45		23.85	A2		23.45		23.85	A2				
	23.75	24.00	24.25	E5		23.75	24.00	24.25	E5				
24	25.70	25.80	26.00	A2	x	25.70	25.80	26.00	A2	150	14 5/8 x 15	10	\$ 2,367.87
	26.10		26.32	E5		26.10		26.32	E5				

All dimensions are in inches

Note: * The high limit of the range is used in the ordering code.
 ** Some transitions may require a stepped center sleeve.
 *** Only available with end codes B2, A1 & E5

ROBAR INDUSTRIES LTD.

BC Phone (604) 591-8811 / 1-800-663-6553
 Fax (604) 591-5288
 Email: waterworks@robarindustries.com

LES PRODUITS INDUSTRIELS ROBAR INC.

QUEBEC Phone (450) 441-7525 / 1-800-315-9525
 Fax (450) 441-4894
 Web www.Robarindustries.com



1408 CAST DUCTILE IRON COUPLINGS

STRAIGHT & TRANSITION
PRICE INFORMATION

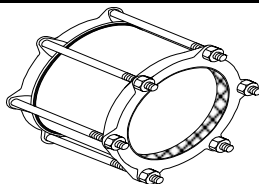

Nom Pipe Size	First End				By X	Second End				MAX. Press. (LBS/IN)	Fasteners No. Dia. X Length	Sleeve Length (IN.)	List Price
	Range			End Code		Range			End Code				
	Low	Pipe OD Actual	High*			Low	Pipe OD Actual	High*					
2	2.35	2.38	2.63	D3	x	2.35	2.38	2.63	D3	300	2 5/8 x 8	5	\$75.17
2.5	2.69	2.88	2.90	D3	x	2.69	2.88	2.90	D3	300	2 5/8 x 8	5	\$83.63
4	3.45	3.50	3.60	4T	x	3.45	3.50	3.60	4T	300	4 5/8 x 8	5	\$122.57
	3.75		4.05	F3A		3.75		4.05	F3A		4 5/8 x 8		
	4.05		4.35	F3B		4.05		4.35	F3B		4 5/8 x 11	7	\$146.84
	4.40	4.50	4.60	D3		4.40	4.50	4.60	D3		4 5/8 x 14	10	\$190.92
	4.74	4.80	5.10	A1		4.74	4.80	5.10	A1				
	5.10		E5	5.10		5.30	E5						
6	5.85		6.15	F3A	x	5.85		6.15	F3A	300	5 5/8 x 8	5	\$176.54
	6.15		6.45	F3B		6.15		6.45	F3B		5 5/8 x 11	7	
	6.50	6.63	6.70	D3		6.50	6.63	6.70	D3		5 - 5/8 x 14	10	\$244.76
	6.86	6.90	7.10	A1		6.86	6.90	7.10	A1				
	7.15		7.35	E5		7.15		7.35	E5				
8	7.90		8.25	F3A	x	7.90		8.25	F3A	300	6 5/8 x 8	5	\$225.55
	8.25		8.55	F3B		8.25		8.55	F3B		6 5/8 x 11	7	
	8.55	8.63	8.75	D3		8.55	8.63	8.75	D3		6 - 5/8 x 14	10	\$320.95
	8.99	9.05	9.30	A1		8.99	9.05	9.30	A1				
	9.30		9.50	E5		9.30		9.50	E5				
10**	9.85		10.20	F4A	x	9.85		10.20	F4A	300	7 5/8 x 11	7	\$414.34
	10.20		10.50	F4B		10.20		10.50	F4B				
	10.60	10.75	10.90	D4		10.60	10.75	10.90	D4				
	11.10	11.10	11.40	B2		11.10	11.10	11.40	B2		7 5/8 x 14	10***	\$532.07
	11.55		11.75	A1		11.55		11.75	A1				
	11.90		12.10	E5		11.90		12.10	E5				
Series 2 (STANDARD STEEL AND DUCTILE SIZES ONLY)													
10	10.60	10.75	10.90	S9	x	10.60	10.75	10.90	S9	300	7 5/8 x 11	7	\$344.62
	11.10	11.10	11.40	G8		11.10	11.10	11.40	G8				

All dimensions are in inches
Continued....

Note: * The high limit of the range is used in the ordering code.
 ** Some transitions may required a stepped center sleeve.
 *** Only available with end codes B2, A1 & E5

ROBAR INDUSTRIES LTD.

BC Phone (604) 591-8811 / 1-800-663-6553
 Fax (604) 591-5288
 Email: waterworks@robarindustries.com

LES PRODUITS INDUSTRIELS ROBAR INC.

QUEBEC Phone (450) 441-7525 / 1-800-315-9525
 Fax (450) 441-4894
 Web www.Robarindustries.com



1408 CAST DUCTILE IRON COUPLINGS

STRAIGHT & TRANSITION

PRICE INFORMATION

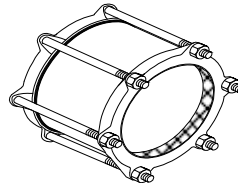

Nom Pipe Size	First End				By X	Second End				MAX. Press. (LBS/IN)	Fasteners No. Dia x Length	Sleeve Length (IN.)	List Price
	Range			End Code		Range			End Code				
	Low	Pipe OD Actual	High*			Low	Pipe OD Actual	High*					
12**	12.00		12.30	F4A	x	12.00		12.30	F4A	300	8 5/8 x 11	7	\$ 471.83
	12.30		12.60	F4B		12.30		12.60	F4B				
	12.60	12.75	12.90	D4		12.60	12.75	12.90	D4				
	13.20	13.20	13.60	B2		13.20	13.20	13.60	B2				
	13.80	14.00	14.10	A1		13.80	14.00	14.10	A1				
	14.10		14.35	E5		14.10		14.35	E5				
Series 2 (STANDARD STEEL AND DUCTILE SIZES ONLY)													
12	12.60	12.75	12.90	S9	x	12.60	12.75	12.90	S9	300	8 5/8 x 11	7	\$ 409.93
	13.20	13.20	13.50	G8		13.20	13.20	13.50	G8				
14	14.60		14.90	F2	x	14.60		14.90	F2	150	9 5/8 x 11	7	\$ 824.89
	15.30	15.30	15.70	B2		15.30	15.30	15.70	B2				
	15.80	16.00	16.25	A1		15.80	16.00	16.25	A1				
	16.40		16.80	E5		16.40		16.80	E5				
16	17.40	17.40	17.80	B2	x	17.40	17.40	17.80	B2	150	10 5/8 x 11	7	\$ 932.82
	17.80	18.00	18.20	A1		17.80	18.00	18.20	A1				
	18.40		18.80	E5		18.40		18.80	E5				
18	18.80		19.20	B1	x	18.80		19.20	B1	150	12 5/8 x 11	7	\$1,224.54
	19.10	19.50	19.70	A2		19.10	19.50	19.70	A2				
	19.70	20.00	20.25	E5		19.70	20.00	20.25	E5				
20	20.80		21.35	B1	x	20.80		21.35	B1	150	12 5/8 x 11	7	\$1,509.71
	21.35	21.60	21.75	A2		21.35	21.60	21.75	A2				
	21.75	22.00	22.25	E5		21.75	22.00	22.25	E5				
22	22.95		23.35	B1	x	22.95		23.35	B1	150	13 5/8 x 11	7	\$1,671.52
	23.45		23.85	A2		23.45		23.85	A2				
	23.75	24.00	24.25	E5		23.75	24.00	24.25	E5				
24	25.70	25.80	26.00	A2	x	25.70	25.80	26.00	A2	150	14 5/8 x 15	10	\$1,852.91
	26.10		26.32	E5		26.10		26.32	E5				

All dimensions are in inches

Note: * The high limit of the range is used in the ordering code.
 ** Some transitions may required a stepped center sleeve.
 *** Only available with end codes B2, A1 & E5

ROBAR INDUSTRIES LTD.	LES PRODUITS INDUSTRIELS ROBAR INC.
BC Phone (604) 591-8811 / 1-800-663-6553	QUEBEC Phone (450) 441-7525 / 1-800-315-9525
Fax (604) 591-5288	Fax (450) 441-4894
Email waterworks@robarindustries.com	Web www.Robarindustries.com

1506 CAST DUCTILE IRON COUPLINGS

STRAIGHT & TRANSITION

PRICE INFORMATION

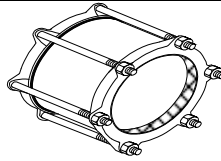

Nom Pipe Size	First End				By X	Second End				MAX. Press. (LBS/IN)	Fasteners No. Dia x Length	Sleeve Length (IN.)	List Price
	Range			End Code		Range			End Code				
	Low	Pipe OD Actual	High*			Low	Pipe OD Actual	High*					
2	2.35	2.38	2.63	D3	x	2.35	2.38	2.63	D3	300	2 5/8 x 8	5	\$114.30
2.5	2.69	2.88	2.90	D3	x	2.69	2.88	2.90	D3	300	2 5/8 x 8	5	\$122.36
4	3.45	3.50	3.60	4T	x	3.45	3.50	3.60	4T	300	4 5/8 x 8	5	\$219.03
	3.75		4.05	F3A		3.75		4.05	F3A				
	4.05		4.35	F3B		4.05		4.35	F3B				
	4.40	4.50	4.60	D3		4.40	4.50	4.60	D3				
	4.74	4.80	5.10	A1		4.74	4.80	5.10	A1				
	5.10		E5		5.10		E5			4 5/8 x 14	10	\$297.79	
6	5.85		6.15	F3A	x	5.85		6.15	F3A	300	5 5/8 x 8	5	\$310.76
	6.15		6.45	F3B		6.15		6.45	F3B				
	6.50	6.63	6.70	D3		6.50	6.63	6.70	D3				
	6.86	6.90	7.10	A1		6.86	6.90	7.10	A1				
	7.15		7.35	E5		7.15		7.35	E5				
										5 - 5/8 x 14	10	\$397.28	
8	7.90		8.25	F3A	x	7.90		8.25	F3A	300	6 5/8 x 8	5	\$389.98
	8.25		8.55	F3B		8.25		8.55	F3B				
	8.55	8.63	8.75	D3		8.55	8.63	8.75	D3				
	8.99	9.05	9.30	A1		8.99	9.05	9.30	A1				
	9.30		9.50	E5		9.30		9.50	E5				
										6 - 5/8 x 14	10	\$530.36	
10**	9.85		10.20	F4A	x	9.85		10.20	F4A	300	7 5/8 x 11	7	\$630.48
	10.20		10.50	F4B		10.20		10.50	F4B				
	10.60	10.75	10.90	D4		10.60	10.75	10.90	D4				
	11.10	11.10	11.40	B2		11.10	11.10	11.40	B2				
	11.55		11.75	A1		11.55		11.75	A1				
	11.90		12.10	E5		11.90		12.10	E5				
										7 5/8 x 14	10***	\$710.62	
Series 2 (STANDARD STEEL AND DUCTILE SIZES ONLY)													
10	10.60	10.75	10.90	S9	x	10.60	10.75	10.90	S9	300	7 5/8 x 11	7	\$551.01
	11.10	11.10	11.40	G8		11.10	11.10	11.40	G8				

All dimensions are in inches
Continued....

Note: * The high limit of the range is used in the ordering code.
 ** Some transitions may required a stepped center sleeve.
 *** Only available with end codes B2, A1 & E5

ROBAR INDUSTRIES LTD.

BC Phone (604) 591-8811 / 1-800-663-6553
 Fax (604) 591-5288
 Email: waterworks@robarindustries.com

LES PRODUITS INDUSTRIELS ROBAR INC.

QUEBEC Phone (450) 441-7525 / 1-800-315-9525
 Fax (450) 441-4894
 Web www.Robarindustries.com



1506 CAST DUCTILE IRON COUPLINGS

STRAIGHT & TRANSITION

PRICE INFORMATION

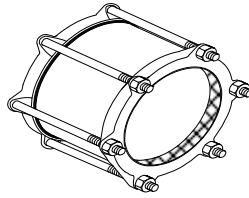

Nom Pipe Size	First End				By X	Second End				MAX. Press. (LBS/IN)	Fasteners No. Dia x Length	Sleeve Length (IN.)	List Price
	Range					Range							
	Low	Pipe OD Actual	High*	End Code		Low	Pipe OD Actual	High*	End Code				
12**	12.00		12.30	F4A	x	12.00		12.30	F4A	300	8 5/8 x 11	7	\$ 712.35
	12.30		12.60	F4B		12.30		12.60	F4B				
	12.60	12.75	12.90	D4		12.60	12.75	12.90	D4				
	13.20	13.20	13.60	B2		13.20	13.20	13.60	B2				
	13.80	14.00	14.10	A1		13.80	14.00	14.10	A1				
	14.10		14.35	E5		14.10		14.35	E5				
											8 5/8 x 14	10***	\$ 825.86

Series 2 (STANDARD STEEL AND DUCTILE SIZES ONLY)

12	12.60	12.75	12.90	S9	x	12.60	12.75	12.90	S9	300	8 5/8 x 11	7	\$ 651.99
	13.20	13.20	13.50	G8		13.20	13.20	13.50	G8				
14	14.60		14.90	F2	x	14.60		14.90	F2	150	9 5/8 x 11	7	\$1,246.96
	15.30	15.30	15.70	B2		15.30	15.30	15.70	B2				
	15.80	16.00	16.25	A1		15.80	16.00	16.25	A1				
	16.40		16.80	E5		16.40		16.80	E5				
16	17.40	17.40	17.80	B2	x	17.40	17.40	17.80	B2	150	10 5/8 x 11	7	\$1,379.53
	17.80	18.00	18.20	A1		17.80	18.00	18.20	A1				
	18.40		18.80	E5		18.40		18.80	E5				
18	18.80		19.20	B1	x	18.80		19.20	B1	150	12 5/8 x 11	7	\$1,669.71
	19.10	19.50	19.70	A2		19.10	19.50	19.70	A2				
	19.70	20.00	20.25	E5		19.70	20.00	20.25	E5				
20	20.80		21.35	B1	x	20.80		21.35	B1	150	12 5/8 x 11	7	\$1,911.46
	21.35	21.60	21.75	A2		21.35	21.60	21.75	A2				
	21.75	22.00	22.25	E5		21.75	22.00	22.25	E5				
22	22.95		23.35	B1	x	22.95		23.35	B1	150	13 5/8 x 11	7	\$2,115.51
	23.45		23.85	A2		23.45		23.85	A2				
	23.75	24.00	24.25	E5		23.75	24.00	24.25	E5				
24	25.70	25.80	26.00	A2	x	25.70	25.80	26.00	A2	150	14 5/8 x 15	10	\$2,658.94
	26.10		26.32	E5		26.10		26.32	E5				

All dimensions are in inches

Note: * The high limit of the range is used in the ordering code.
 ** Some transitions may required a stepped center sleeve.
 *** Only available with end codes B2, A1 & E5

ROBAR INDUSTRIES LTD.

BC Phone (604) 591-8811 / 1-800-663-6553
 Fax (604) 591-5288
 Email waterworks@robarindustries.com

LES PRODUITS INDUSTRIELS ROBAR INC.

QUEBEC Phone (450) 441-7525 / 1-800-315-9525
 Fax (450) 441-4894
 Web www.Robarindustries.com



1507 CAST DUCTILE IRON COUPLINGS

STRAIGHT & TRANSITION
PRICE INFORMATION

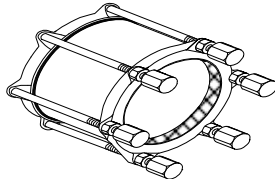

Nom Pipe Size	First End				By X	Second End				MAX. Press. (LBS/IN)	Fasteners No. Dia x Length	Sleeve Length (IN.)	List Price
	Range			End Code		Range			End Code				
	Low	Pipe OD Actual	High*			Low	Pipe OD Actual	High*					
2	2.35	2.38	2.63	D3	x	2.35	2.38	2.63	D3	300	2 5/8 x 8	5	\$131.20
2.5	2.69	2.88	2.90	D3	x	2.69	2.88	2.90	D3	300	2 5/8 x 8	5	\$157.94
4	3.45	3.50	3.60	4T	x	3.45	3.50	3.60	4T	300	4 5/8 x 8	5	\$248.58
	3.75		4.05	F3A		3.75		4.05	F3A				
	4.05		4.35	F3B		4.05		4.35	F3B				
	4.40	4.50	4.60	D3		4.40	4.50	4.60	D3				
	4.74	4.80	5.10	A1		4.74	4.80	5.10	A1				
	5.10		5.30	E5		5.10		5.30	E5				
6	5.85		6.15	F3A	x	5.85		6.15	F3A	300	5 5/8 x 8	5	\$347.68
	6.15		6.45	F3B		6.15		6.45	F3B				
	6.50	6.63	6.70	D3		6.50	6.63	6.70	D3				
	6.86	6.90	7.10	A1		6.86	6.90	7.10	A1				
	7.15		7.35	E5		7.15		7.35	E5				
	7.90		8.25	F3A		7.90		8.25	F3A				
8	8.25		8.55	F3B	x	8.25		8.55	F3B	300	6 5/8 x 8	5	\$434.28
	8.55	8.63	8.75	D3		8.55	8.63	8.75	D3				
	8.99	9.05	9.30	A1		8.99	9.05	9.30	A1				
	9.30		9.50	E5		9.30		9.50	E5				
	9.85		10.20	F4A		9.85		10.20	F4A				
	10.20		10.50	F4B		10.20		10.50	F4B				
10**	10.60	10.75	10.90	D4	x	10.60	10.75	10.90	D4	300	7 5/8 x 11	7	\$678.88
	11.10	11.10	11.40	B2		11.10	11.10	11.40	B2				
	11.55		11.75	A1		11.55		11.75	A1				
	11.90		12.10	E5		11.90		12.10	E5				
	10.60	10.75	10.90	S9		10.60	10.75	10.90	S9				
	11.10	11.10	11.40	G8		11.10	11.10	11.40	G8				
Series 2 (STANDARD STEEL AND DUCTILE SIZES ONLY)													
10	10.60	10.75	10.90	S9	x	10.60	10.75	10.90	S9	300	7 5/8 x 11	7	\$599.42
	11.10	11.10	11.40	G8		11.10	11.10	11.40	G8				

All dimensions are in inches
Continued....

Note: * The high limit of the range is used in the ordering code.
** Some transitions may required a stepped center sleeve.

ROBAR INDUSTRIES LTD.

BC Phone (604) 591-8811 / 1-800-663-6553
Fax (604) 591-5288
Email: waterworks@robarindustries.com

LES PRODUITS INDUSTRIELS ROBAR INC.

QUEBEC Phone (450) 441-7525 / 1-800-315-9525
Fax (450) 441-4894
Web www.Robarindustries.com



1507 CAST DUCTILE IRON COUPLINGS

STRAIGHT & TRANSITION
PRICE INFORMATION

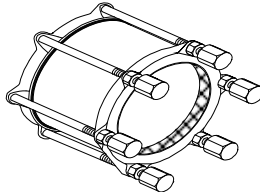

Nom Pipe Size	First End				By X	Second End				MAX. Press. (LBS/IN)	Fasteners No. Dia x Length	Sleeve Length (IN.)	List Price
	Range					Range							
	Low	Pipe OD Actual	High*	End Code		Low	Pipe OD Actual	High*	End Code				
12**	12.00		12.30	F4A	x	12.00		12.30	F4A	300	8 5/8 x 11	7	\$ 767.72
	12.30		12.60	F4B		12.30		12.60	F4B				
	12.60	12.75	12.90	D4		12.60	12.75	12.90	D4				
	13.20	13.20	13.60	B2		13.20	13.20	13.60	B2				
	13.80	14.00	14.10	A1		13.80	14.00	14.10	A1				
	14.10		14.35	E5		14.10		14.35	E5				
Series 2 (STANDARD STEEL AND DUCTILE SIZES ONLY)													
12	12.60	12.75	12.90	S9	x	12.60	12.75	12.90	S9	300	8 5/8 x 11	7	\$ 711.03
	13.20	13.20	13.50	G8		13.20	13.20	13.50	G8				
14	14.60		14.90	F2	x	14.60		14.90	F2	150	9 5/8 x 11	7	\$1,314.01
	15.30	15.30	15.70	B2		15.30	15.30	15.70	B2				
	15.80	16.00	16.25	A1		15.80	16.00	16.25	A1				
	16.40		16.80	E5		16.40		16.80	E5				
16	17.40	17.40	17.80	B2	x	17.40	17.40	17.80	B2	150	10 5/8 x 11	7	\$1,454.78
	17.80	18.00	18.20	A1		17.80	18.00	18.20	A1				
	18.40		18.80	E5		18.40		18.80	E5				
18	18.80		19.20	B1	x	18.80		19.20	B1	150	12 5/8 x 11	7	\$1,759.91
	19.10	19.50	19.70	A2		19.10	19.50	19.70	A2				
	19.70	20.00	20.25	E5		19.70	20.00	20.25	E5				
20	20.80		21.35	B1	x	20.80		21.35	B1	150	12 5/8 x 11	7	\$2,001.69
	21.35	21.60	21.75	A2		21.35	21.60	21.75	A2				
	21.75	22.00	22.25	E5		21.75	22.00	22.25	E5				
22	22.95		23.35	B1	x	22.95		23.35	B1	150	13 5/8 x 11	7	\$2,213.24
	23.45		23.85	A2		23.45		23.85	A2				
	23.75	24.00	24.25	E5		23.75	24.00	24.25	E5				
24	25.70	25.80	26.00	A2	x	25.70	25.80	26.00	A2	150	14 5/8 x 15	10	\$2,461.44
	26.10		26.32	E5		26.10		26.32	E5				

All dimensions are in inches

Note: * The high limit of the range is used in the ordering code.
** Some transitions may required a stepped center sleeve.

ROBAR INDUSTRIES LTD.

BC Phone (604) 591-8811 / 1-800-663-6553
Fax (604) 591-5288
Email: waterworks@robarindustries.com

LES PRODUITS INDUSTRIELS ROBAR INC.

QUEBEC Phone (450) 441-7525 / 1-800-315-9525
Fax (450) 441-4894
Web www.Robarindustries.com



1508 CAST DUCTILE IRON COUPLINGS

STRAIGHT & TRANSITION
PRICE INFORMATION

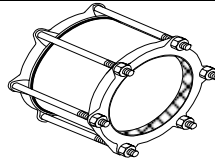

Nom Pipe Size	First End				By X	Second End				MAX. Press. (LBS/IN)	Fasteners No. Dia x Length	Sleeve Length (IN.)	List Price
	Range			End Code		Range			End Code				
	Low	Pipe OD Actual	High*			Low	Pipe OD Actual	High*					
2	2.35	2.38	2.63	D3	x	2.35	2.38	2.63	D3	300	2 5/8 x 8	5	\$100.43
2.5	2.69	2.88	2.90	D3	x	2.69	2.88	2.90	D3	300	2 5/8 x 8	5	\$108.67
4	3.45	3.50	3.60	4T	x	3.45	3.50	3.60	4T	300	4 5/8 x 8	5	\$166.36
	3.75		4.05	F3A		3.75		4.05	F3A				
	4.05		4.35	F3B		4.05		4.35	F3B				
	4.40	4.50	4.60	D3		4.40	4.50	4.60	D3				
	4.74	4.80	5.10	A1		4.74	4.80	5.10	A1				
	5.10		E5		5.10		E5			4 5/8 x 11	7	\$196.08	
											4 5/8 x 14	10	\$241.48
6	5.85		6.15	F3A	x	5.85		6.15	F3A	300	5 5/8 x 8	5	\$231.73
	6.15		6.45	F3B		6.15		6.45	F3B				
	6.50	6.63	6.70	D3		6.50	6.63	6.70	D3				
	6.86	6.90	7.10	A1		6.86	6.90	7.10	A1				
	7.15		7.35	E5		7.15		7.35	E5				
										5 - 5/8 x 14	10	\$308.20	
8	7.90		8.25	F3A	x	7.90		8.25	F3A	300	6 5/8 x 8	5	\$292.63
	8.25		8.55	F3B		8.25		8.55	F3B				
	8.55	8.63	8.75	D3		8.55	8.63	8.75	D3				
	8.99	9.05	9.30	A1		8.99	9.05	9.30	A1				
	9.30		9.50	E5		9.30		9.50	E5				
										6 - 5/8 x 14	10	\$405.69	
10**	9.85		10.20	F4A	x	9.85		10.20	F4A	300	7 5/8 x 11	7	\$487.23
	10.20		10.50	F4B		10.20		10.50	F4B				
	10.60	10.75	10.90	D4		10.60	10.75	10.90	D4				
	11.10	11.10	11.40	B2		11.10	11.10	11.40	B2				
	11.55		11.75	A1		11.55		11.75	A1				
	11.90		12.10	E5		11.90		12.10	E5				
										7 5/8 x 14	10***	\$579.50	
Series 2 (STANDARD STEEL AND DUCTILE SIZES ONLY)													
10	10.60	10.75	10.90	S9	x	10.60	10.75	10.90	S9	300	7 5/8 x 11	7	\$426.34
	11.10	11.10	11.40	G8		11.10	11.10	11.40	G8				

All dimensions are in inches
Continued...

Note: * The high limit of the range is used in the ordering code.
 ** Some transitions may required a stepped center sleeve.
 *** Only available with end codes B2, A1 & E5

ROBAR INDUSTRIES LTD.

BC Phone (604) 591-8811 / 1-800-663-6553
 Fax (604) 591-5288
 Email: waterworks@robarindustries.com

LES PRODUITS INDUSTRIELS ROBAR INC.

QUEBEC Phone (450) 441-7525 / 1-800-315-9525
 Fax (450) 441-4894
 Web www.Robarindustries.com



1508 CAST DUCTILE IRON COUPLINGS

STRAIGHT & TRANSITION
PRICE INFORMATION

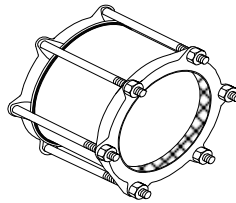

Nom Pipe Size	First End				By X	Second End				MAX. Press. (LBS/IN)	Fasteners No. Dia x Length	Sleeve Length (IN.)	List Price
	Range					Range							
	Low	Pipe OD Actual	High*	End Code		Low	Pipe OD Actual	High*	End Code				
12**	12.00		12.30	F4A	x	12.00		12.30	F4A	300	8 5/8 x 11	7	\$ 577.84
	12.30		12.60	F4B		12.30		12.60	F4B				
	12.60	12.75	12.90	D4		12.60	12.75	12.90	D4				
	13.20	13.20	13.60	B2		13.20	13.20	13.60	B2				
	13.80	14.00	14.10	A1		13.80	14.00	14.10	A1				
	14.10		14.35	E5		14.10		14.35	E5				
Series 2 (STANDARD STEEL AND DUCTILE SIZES ONLY)													
12	12.60	12.75	12.90	S9	x	12.60	12.75	12.90	S9	300	8 5/8 x 11	7	\$ 530.33
	13.20	13.20	13.50	G8		13.20	13.20	13.50	G8				
14	14.60		14.90	F2	x	14.60		14.90	F2	150	9 5/8 x 11	7	\$ 984.86
	15.30	15.30	15.70	B2		15.30	15.30	15.70	B2				
	15.80	16.00	16.25	A1		15.80	16.00	16.25	A1				
	16.40		16.80	E5		16.40		16.80	E5				
16	17.40	17.40	17.80	B2	x	17.40	17.40	17.80	B2	150	10 5/8 x 11	7	\$ 1,189.85
	17.80	18.00	18.20	A1		17.80	18.00	18.20	A1				
	18.40		18.80	E5		18.40		18.80	E5				
18	18.80		19.20	B1	x	18.80		19.20	B1	150	12 5/8 x 11	7	\$ 1,406.72
	19.10	19.50	19.70	A2		19.10	19.50	19.70	A2				
	19.70	20.00	20.25	E5		19.70	20.00	20.25	E5				
20	20.80		21.35	B1	x	20.80		21.35	B1	150	12 5/8 x 11	7	\$ 1,586.47
	21.35	21.60	21.75	A2		21.35	21.60	21.75	A2				
	21.75	22.00	22.25	E5		21.75	22.00	22.25	E5				
22	22.95		23.35	B1	x	22.95		23.35	B1	150	13 5/8 x 11	7	\$ 1,752.84
	23.45		23.85	A2		23.45		23.85	A2				
	23.75	24.00	24.25	E5		23.75	24.00	24.25	E5				
24	25.70	25.80	26.00	A2	x	25.70	25.80	26.00	A2	150	14 5/8 x 15	10	\$ 2,100.44
	26.10		26.32	E5		26.10		26.32	E5				

All dimensions are in inches

Note: * The high limit of the range is used in the ordering code.
 ** Some transitions may required a stepped center sleeve.
 *** Only available with end codes B2, A1 & E5

ROBAR INDUSTRIES LTD.

BC Phone (604) 591-8811 / 1-800-663-6553
 Fax (604) 591-5288
 Email: waterworks@robarindustries.com

LES PRODUITS INDUSTRIELS ROBAR INC.

QUEBEC Phone (450) 441-7525 / 1-800-315-9525
 Fax (450) 441-4894
 Web www.Robarindustries.com



1519 CAST DUCTILE IRON COUPLINGS

STRAIGHT & TRANSITION
PRICE INFORMATION

Nom Pipe Size	First End				By X	Second End				MAX. Press. (LBS/IN)	Fasteners No. Dia x Length	Sleeve Length (IN.)	List Price
	Range			End Code		Range			End Code				
	Low	Pipe OD Actual	High*			Low	Pipe OD Actual	High*					
2	2.35	2.38	2.63	D3	x	2.35	2.38	2.63	D3	300	2 5/8 x 8	5	\$110.75
2.5	2.69	2.88	2.90	D3	x	2.69	2.88	2.90	D3	300	2 5/8 x 8	5	\$119.52
4	3.45	3.50	3.60	4T	x	3.45	3.50	3.60	4T	300	4 5/8 x 8	5	\$190.86
	3.75		4.05	F3A		3.75		4.05	F3A				
	4.05		4.35	F3B		4.05		4.35	F3B				
	4.40	4.50	4.60	D3		4.40	4.50	4.60	D3				
	4.74	4.80	5.10	A1		4.74	4.80	5.10	A1				
	5.10		5.30	E5		5.10		5.30	E5				
6	5.85		6.15	F3A	x	5.85		6.15	F3A	300	5 5/8 x 8	5	\$274.08
	6.15		6.45	F3B		6.15		6.45	F3B				
	6.50	6.63	6.70	D3		6.50	6.63	6.70	D3				
	6.86	6.90	7.10	A1		6.86	6.90	7.10	A1				
	7.15		7.35	E5		7.15		7.35	E5				
8	7.90		8.25	F3A	x	7.90		8.25	F3A	300	6 5/8 x 8	5	\$351.84
	8.25		8.55	F3B		8.25		8.55	F3B				
	8.55	8.63	8.75	D3		8.55	8.63	8.75	D3				
	8.99	9.05	9.30	A1		8.99	9.05	9.30	A1				
	9.30		9.50	E5		9.30		9.50	E5				
10**	9.85		10.20	F4A	x	9.85		10.20	F4A	300	7 5/8 x 11	7	\$573.59
	10.20		10.50	F4B		10.20		10.50	F4B				
	10.60	10.75	10.90	D4		10.60	10.75	10.90	D4				
	11.10	11.10	11.40	B2		11.10	11.10	11.40	B2				
	11.55		11.75	A1		11.55		11.75	A1				
	11.90		12.10	E5		11.90		12.10	E5				
Series 2 (STANDARD STEEL AND DUCTILE SIZES ONLY)													
10	10.60	10.75	10.90	S9	x	10.60	10.75	10.90	S9	300	7 5/8 x 11	7	\$494.11
	11.10	11.10	11.40	G8		11.10	11.10	11.40	G8				

All dimensions are in inches
Continued....

Note: * The high limit of the range is used in the ordering code.
** Some transitions may required a stepped center sleeve.

ROBAR INDUSTRIES LTD.

BC Phone (604) 591-8811 / 1-800-663-6553
Fax (604) 591-5288
Email: waterworks@robarindustries.com

LES PRODUITS INDUSTRIELS ROBAR INC.

QUEBEC Phone (450) 441-7525 / 1-800-315-9525
Fax (450) 441-4894
Web www.Robarindustries.com



1519 CAST DUCTILE IRON COUPLINGS

STRAIGHT & TRANSITION
PRICE INFORMATION

Nom Pipe Size	First End				By X	Second End				MAX. Press. (LBS/IN)	Fasteners No. Dia x Length	Sleeve Length (IN.)	List Price
	Range			End Code		Range			End Code				
	Low	Pipe OD Actual	High*			Low	Pipe OD Actual	High*					
12**	12.00		12.30	F4A	x	12.00		12.30	F4A	300	8 5/8 x 11	7	\$ 646.47
	12.30		12.60	F4B		12.30		12.60	F4B				
	12.60	12.75	12.90	D4		12.60	12.75	12.90	D4				
	13.20	13.20	13.60	B2		13.20	13.20	13.60	B2				
	13.80	14.00	14.10	A1		13.80	14.00	14.10	A1				
	14.10		14.35	E5		14.10		14.35	E5				
Series 2 (STANDARD STEEL AND DUCTILE SIZES ONLY)													
12	12.60	12.75	12.90	S9	x	12.60	12.75	12.90	S9	300	8 5/8 x 11	7	\$ 581.73
	13.20	13.20	13.50	G8		13.20	13.20	13.50	G8				
14	14.60		14.90	F2	x	14.60		14.90	F2	150	9 5/8 x 11	7	\$ 1,165.70
	15.30	15.30	15.70	B2		15.30	15.30	15.70	B2				
	15.80	16.00	16.25	A1		15.80	16.00	16.25	A1				
	16.40		16.80	E5		16.40		16.80	E5				
16	17.40	17.40	17.80	B2	x	17.40	17.40	17.80	B2	150	10 5/8 x 11	7	\$ 1,288.56
	17.80	18.00	18.20	A1		17.80	18.00	18.20	A1				
	18.40		18.80	E5		18.40		18.80	E5				
18	18.80		19.20	B1	x	18.80		19.20	B1	150	12 5/8 x 11	7	\$ 1,559.14
	19.10	19.50	19.70	A2		19.10	19.50	19.70	A2				
	19.70	20.00	20.25	E5		19.70	20.00	20.25	E5				
20	20.80		21.35	B1	x	20.80		21.35	B1	150	12 5/8 x 11	7	\$ 1,800.89
	21.35	21.60	21.75	A2		21.35	21.60	21.75	A2				
	21.75	22.00	22.25	E5		21.75	22.00	22.25	E5				
22	22.95		23.35	B1	x	22.95		23.35	B1	150	13 5/8 x 11	7	\$ 1,995.13
	23.45		23.85	A2		23.45		23.85	A2				
	23.75	24.00	24.25	E5		23.75	24.00	24.25	E5				
24	25.70	25.80	26.00	A2	x	25.70	25.80	26.00	A2	150	14 5/8 x 15	10	\$ 2,226.09
	26.10		26.32	E5		26.10		26.32	E5				

All dimensions are in inches

Note: * The high limit of the range is used in the ordering code.
** Some transitions may required a stepped center sleeve.

ROBAR INDUSTRIES LTD.

BC Phone (604) 591-8811 / 1-800-663-6553
Fax (604) 591-5288
Email: waterworks@robarindustries.com

LES PRODUITS INDUSTRIELS ROBAR INC.

QUEBEC Phone (450) 441-7525 / 1-800-315-9525
Fax (450) 441-4894
Web www.Robarindustries.com



1406R REDUCING COUPLINGS

CAST DUCTILE IRON
PRICE INFORMATION

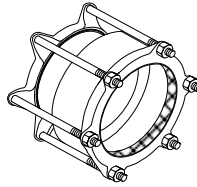

Nom Pipe Size	First End				By X	Second End				MAX. Press. (LBS/IN)	Fasteners No. Dia x Length	Sleeve length (IN.)	List Price
	Range					Range							
	Low	Pipe OD Actual	High*	End Code		Low	Pipe OD Actual	High*	End Code				
6 x 4	5.85		6.15	F3A	x	3.45	3.50	3.60	4T	300	5 5/8 x 8	5	\$312.35
	6.15		6.45	F3B		3.75		4.05	F3A				
	6.50	6.63	6.70	D3		4.05		4.35	F3B				
	6.86	6.90	7.10	A1		4.40	4.50	4.60	D3				
	7.15		7.35	E5		4.74	4.80	5.10	A1				
						5.10		5.30	E5				
8 x 6	7.90		8.25	F3A	x	5.85		6.15	F3A	300	6 5/8 x 8	5	\$397.13
	8.25		8.55	F3B		6.15		6.45	F3B				
	8.55	8.63	8.75	D3		6.50	6.63	6.70	D3				
	8.99	9.05	9.30	A1		6.86	6.90	7.10	A1				
	9.30		9.50	E5		7.15		7.35	E5				
10 x 8	9.85		10.20	F4A	x	7.90		8.25	F3A	300	7 5/8 x 11	7	\$615.41
	10.20		10.50	F4B		8.25		8.55	F3B				
	10.60	10.75	10.90	D4		8.55	8.63	8.75	D3				
	11.10	11.10	11.40	B2		8.99	9.05	9.30	A1				
	11.55		11.75	A1		9.30		9.50	E5				
	11.90		12.10	E5									
12 x 10	12.00		12.30	F4A	x	9.85		10.20	F4A	300	8 5/8 x 11	7	\$704.02
	12.30		12.60	F4B		10.20		10.50	F4B				
	12.60	12.75	12.90	D4		10.60	10.75	10.90	D4				
	13.20	13.20	13.60	B2		11.10	11.10	11.40	B2				
	13.80	14.00	14.10	A1		11.55		11.75	A1				
	14.10		14.35	E5		11.90		12.10	E5				
14 x 12	14.60		14.90	F2	x	12.00		12.30	F4A	150	9 5/8 x 11	7	\$1,057.57
	15.30	15.30	15.70	B2		12.30		12.60	F4B				
	15.80	16.00	16.25	A1		12.60	12.75	12.90	D4				
	16.40		16.80	E5		13.20	13.20	13.60	B2				
						13.80	14.00	14.10	A1				
						14.10		14.35	E5				

All dimensions are in inches
Continued....

Note: * The high limit of the range is used in the ordering code.

ROBAR INDUSTRIES LTD.

BC Phone (604) 591-8811 / 1-800-663-6553
Fax (604) 591-5288
Email: waterworks@robarindustries.com

LES PRODUITS INDUSTRIELS ROBAR INC.

QUEBEC Phone (450) 441-7525 / 1-800-315-9525
Fax (450) 441-4894
Web www.Robarindustries.com



1406R REDUCING COUPLINGS

CAST DUCTILE IRON
PRICE INFORMATION

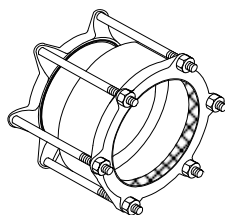

Nom Pipe Size	First End				By X	Second End				MAX. Press. (LBS/IN)	Fasteners No. Dia x Length	Sleeve Length (IN.)	List Price
	Range					Range							
	Low	Pipe OD Actual	High*	End Code		Low	Pipe OD Actual	High*	End Code				
16 x 14					x	14.60		14.90	F2	150	10 5/8 x 11	7	\$1,289.32
	17.40	17.40	17.80	B2		15.30	15.30	15.70	B2				
	17.80	18.00	18.20	A1		15.80	16.00	16.25	A1				
	18.40		18.80	E5		16.40		16.80	E5				
18 x 16	18.80		19.20	B1	x	17.40	17.40	17.80	B2	150	12 5/8 x 11	7	\$1,600.88
	19.10	19.50	19.70	A2		17.80	18.00	18.20	A1				
	19.70	20.00	20.25	E5		18.40		18.80	E5				
20 x 16	20.80		21.35	B1	x	17.40	17.40	17.80	B2	150	12 5/8 x 11	7	\$1,848.08
	21.35	21.60	21.75	A2		17.80	18.00	18.20	A1				
	21.75	22.00	22.25	E5		18.40		18.80	E5				
20 x 18	20.80		21.35	B1	x	18.80		19.20	B1	150	12 5/8 x 11	7	\$1,796.75
	21.35	21.60	21.75	A2		19.10	19.50	19.70	A2				
	21.75	22.00	22.25	E5		19.70	20.00	20.25	E5				
22 x 16	22.95		23.35	B1	x	17.40	17.40	17.80	B2	150	13 5/8 x 11	7	\$2,070.33
	23.45		23.85	A2		17.80	18.00	18.20	A1				
	23.75	24.00	24.25	E5		18.40		18.80	E5				
22 x 18	22.95		23.35	B1	x	18.80		19.20	B1	150	13 5/8 x 11	7	\$2,065.85
	23.45		23.85	A2		19.10	19.50	19.70	A2				
	23.75	24.00	24.25	E5		19.70	20.00	20.25	E5				
22 x 20	22.95		23.35	B1	x	20.80		21.35	B1	150	13 5/8 x 11	7	\$1,910.64
	23.45		23.85	A2		21.35	21.60	21.75	A2				
	23.75	24.00	24.25	E5		21.75	22.00	22.25	E5				
24 x 22	25.70	25.80	26.00	A2	x	22.95		23.35	B1	150	14 5/8 x 15	10	\$2,574.84
	26.10		26.32	E5		23.45		23.85	A2				
						23.75	24.00	24.25	E5				

All dimensions are in inches

Note: * The high limit of the range is used in the ordering code.

ROBAR INDUSTRIES LTD.

BC Phone (604) 591-8811 / 1-800-663-6553
 Fax (604) 591-5288
 Email: waterworks@robarindustries.com

LES PRODUITS INDUSTRIELS ROBAR INC.

QUEBEC Phone (450) 441-7525 / 1-800-315-9525
 Fax (450) 441-4894
 Web www.Robarindustries.com



1408R REDUCING COUPLINGS

CAST DUCTILE IRON
PRICE INFORMATION

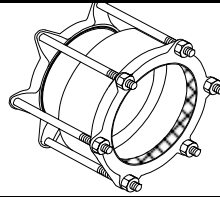

Nom Pipe Size	First End				By X	Second End				MAX. Press. (LBS/IN)	Fasteners No. Dia x Length	Sleeve Length (IN.)	List Price
	Range					Range							
	Low	Pipe OD Actual	High*	End Code		Low	Pipe OD Actual	High*	End Code				
6 x 4	5.85		6.15	F3A	x	3.45	3.50	3.60	4T	300	5 5/8 x 8	5	\$247.94
	6.15		6.45	F3B		3.75		4.05	F3A				
	6.50	6.63	6.70	D3		4.05		4.35	F3B				
	6.86	6.90	7.10	A1		4.40	4.50	4.60	D3				
	7.15		7.35	E5		4.74	4.80	5.10	A1				
						5.10		5.30	E5				
8 x 6	7.90		8.25	F3A	x	5.85		6.15	F3A	300	6 5/8 x 8	5	\$320.36
	8.25		8.55	F3B		6.15		6.45	F3B				
	8.55	8.63	8.75	D3		6.50	6.63	6.70	D3				
	8.99	9.05	9.30	A1		6.86	6.90	7.10	A1				
	9.30		9.50	E5		7.15		7.35	E5				
10 x 8	9.85		10.20	F4A	x	7.90		8.25	F3A	300	7 5/8 x 11	7	\$523.60
	10.20		10.50	F4B		8.25		8.55	F3B				
	10.60	10.75	10.90	D4		8.55	8.63	8.75	D3				
	11.10	11.10	11.40	B2		8.99	9.05	9.30	A1				
	11.55		11.75	A1		9.30		9.50	E5				
	11.90		12.10	E5									
12 x 10	12.00		12.30	F4A	x	9.85		10.20	F4A	300	8 5/8 x 11	7	\$599.10
	12.30		12.60	F4B		10.20		10.50	F4B				
	12.60	12.75	12.90	D4		10.60	10.75	10.90	D4				
	13.20	13.20	13.60	B2		11.10	11.10	11.40	B2				
	13.80	14.00	14.10	A1		11.55		11.75	A1				
	14.10		14.35	E5		11.90		12.10	E5				
14 x 12	14.60		14.90	F2	x	12.00		12.30	F4A	150	9 5/8 x 11	7	\$944.46
	15.30	15.30	15.70	B2		12.30		12.60	F4B				
	15.80	16.00	16.25	A1		12.60	12.75	12.90	D4				
	16.40		16.80	E5		13.20	13.20	13.60	B2				
						13.80	14.00	14.10	A1				
						14.10		14.35	E5				

All dimensions are in inches
Continued...

Note: * The high limit of the range is used in the ordering code.

ROBAR INDUSTRIES LTD.

BC Phone (604) 591-8811 / 1-800-663-6553
Fax (604) 591-5288
Email: waterworks@robarindustries.com

LES PRODUITS INDUSTRIELS ROBAR INC.

QUEBEC Phone (450) 441-7525 / 1-800-315-9525
Fax (450) 441-4894
Web www.Robarindustries.com

1408R REDUCING COUPLINGS

CAST DUCTILE IRON
PRICE INFORMATION

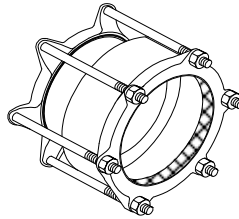

Nom Pipe Size	First End				By X	Second End				MAX. Press. (LBS/IN)	Fasteners No. Dia x Length	Sleeve Length (IN.)	List Price
	Range			End Code		Range			End Code				
	Low	Pipe OD Actual	High*			Low	Pipe OD Actual	High*					
16 x 14					x	14.60		14.90	F2	150	10 5/8 x 11	7	\$ 1,153.01
	17.40	17.40	17.80	B2		15.30	15.30	15.70	B2				
	17.80	18.00	18.20	A1		15.80	16.00	16.25	A1				
	18.40		18.80	E5		16.40		16.80	E5				
18 x 16	18.80		19.20	B1	x	17.40	17.40	17.80	B2	150	12 5/8 x 11	7	\$ 1,438.27
	19.10	19.50	19.70	A2		17.80	18.00	18.20	A1				
	19.70	20.00	20.25	E5		18.40		18.80	E5				
20 x 16	20.80		21.35	B1	x	17.40	17.40	17.80	B2	150	12 5/8 x 11	7	\$ 1,690.05
	21.35	21.60	21.75	A2		17.80	18.00	18.20	A1				
	21.75	22.00	22.25	E5		18.40		18.80	E5				
20 x 18	20.80		21.35	B1	x	18.80		19.20	B1	150	12 5/8 x 11	7	\$ 1,637.74
	21.35	21.60	21.75	A2		19.10	19.50	19.70	A2				
	21.75	22.00	22.25	E5		19.70	20.00	20.25	E5				
22 x 16	22.95		23.35	B1	x	17.40	17.40	17.80	B2	150	13 5/8 x 11	7	\$ 1,900.42
	23.45		23.85	A2		17.80	18.00	18.20	A1				
	23.75	24.00	24.25	E5		18.40		18.80	E5				
22 x 18	22.95		23.35	B1	x	18.80		19.20	B1	150	13 5/8 x 11	7	\$ 1,895.87
	23.45		23.85	A2		19.10	19.50	19.70	A2				
	23.75	24.00	24.25	E5		19.70	20.00	20.25	E5				
22 x 20	22.95		23.35	B1	x	20.80		21.35	B1	150	13 5/8 x 11	7	\$ 1,737.74
	23.45		23.85	A2		21.35	21.60	21.75	A2				
	23.75	24.00	24.25	E5		21.75	22.00	22.25	E5				
24 x 22	25.70	25.80	26.00	A2	x	22.95		23.35	B1	150	14 5/8 x 15	10	\$ 2,063.72
	26.10		26.32	E5		23.45		23.85	A2				
						23.75	24.00	24.25	E5				

All dimensions are in inches

Note: * The high limit of the range is used in the ordering code.

ROBAR INDUSTRIES LTD.

BC Phone (604) 591-8811 / 1-800-663-6553
Fax (604) 591-5288
Email waterworks@robarindustries.com

LES PRODUITS INDUSTRIELS ROBAR INC.

QUEBEC Phone (450) 441-7525 / 1-800-315-9525
Fax (450) 441-4894
Web www.Robarindustries.com



1506R REDUCING COUPLINGS

CAST DUCTILE IRON
PRICE INFORMATION

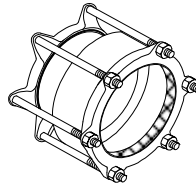

Nom Pipe Size	First End				By X	Second End				MAX. Press. (LBS/IN)	Fasteners No. Dia x Length	Sleeve Length (IN.)	List Price
	Range					Range							
	Low	Pipe OD Actual	High*	End Code		Low	Pipe OD Actual	High*	End Code				
6 x 4	5.85		6.15	F3A	x	3.45	3.50	3.60	4T	300	5 5/8 x 8	5	\$424.20
	6.15		6.45	F3B		3.75		4.05	F3A				
	6.50	6.63	6.70	D3		4.05		4.35	F3B				
	6.86	6.90	7.10	A1		4.40	4.50	4.60	D3				
	7.15		7.35	E5		4.74	4.80	5.10	A1				
						5.10		5.30	E5				
8 x 6	7.90		8.25	F3A	x	5.85		6.15	F3A	300	6 5/8 x 8	5	\$542.48
	8.25		8.55	F3B		6.15		6.45	F3B				
	8.55	8.63	8.75	D3		6.50	6.63	6.70	D3				
	8.99	9.05	9.30	A1		6.86	6.90	7.10	A1				
	9.30		9.50	E5		7.15		7.35	E5				
10 x 8	9.85		10.20	F4A	x	7.90		8.25	F3A	300	7 5/8 x 11	7	\$854.92
	10.20		10.50	F4B		8.25		8.55	F3B				
	10.60	10.75	10.90	D4		8.55	8.63	8.75	D3				
	11.10	11.10	11.40	B2		8.99	9.05	9.30	A1				
	11.55		11.75	A1		9.30		9.50	E5				
	11.90		12.10	E5									
12 x 10	12.00		12.30	F4A	x	9.85		10.20	F4A	300	8 5/8 x 11	7	\$971.44
	12.30		12.60	F4B		10.20		10.50	F4B				
	12.60	12.75	12.90	D4		10.60	10.75	10.90	D4				
	13.20	13.20	13.60	B2		11.10	11.10	11.40	B2				
	13.80	14.00	14.10	A1		11.55		11.75	A1				
	14.10		14.35	E5		11.90		12.10	E5				
14 x 12	14.60		14.90	F2	x	12.00		12.30	F4A	150	9 5/8 x 11	7	\$1,500.54
	15.30	15.30	15.70	B2		12.30		12.60	F4B				
	15.80	16.00	16.25	A1		12.60	12.75	12.90	D4				
	16.40		16.80	E5		13.20	13.20	13.60	B2				
						13.80	14.00	14.10	A1				
						14.10		14.35	E5				

All dimensions are in inches

Note: * The high limit of the range is used in the ordering code.

ROBAR INDUSTRIES LTD.

BC Phone (604) 591-8811 / 1-800-663-6553
 Fax (604) 591-5288
 Email: waterworks@robarindustries.com

LES PRODUITS INDUSTRIELS ROBAR INC.

QUEBEC Phone (450) 441-7525 / 1-800-315-9525
 Fax (450) 441-4894
 Web www.Robarindustries.com

1506R REDUCING COUPLINGS

CAST DUCTILE IRON
PRICE INFORMATION

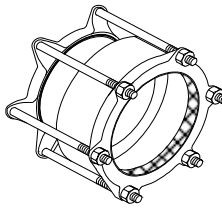

Nom Pipe Size	First End				By X	Second End				MAX. Press. (LBS/IN)	Fasteners No. Dia x Length	Sleeve Length (IN.)	List Price
	Range			End Code		Range			End Code				
	Low	Pipe OD Actual	High*			Low	Pipe OD Actual	High*					
16 x 14					x	14.60		14.90	F2	150	10 5/8 x 11	7	\$ 1,806.67
	17.40	17.40	17.80	B2		15.30	15.30	15.70	B2				
	17.80	18.00	18.20	A1		15.80	16.00	16.25	A1				
	18.40		18.80	E5		16.40		16.80	E5				
18 x 16	18.80		19.20	B1	x	17.40	17.40	17.80	B2	150	12 5/8 x 11	7	\$ 2,299.74
	19.10	19.50	19.70	A2		17.80	18.00	18.20	A1				
	19.70	20.00	20.25	E5		18.40		18.80	E5				
20 x 16	20.80		21.35	B1	x	17.40	17.40	17.80	B2	150	12 5/8 x 11	7	\$ 2,569.62
	21.35	21.60	21.75	A2		17.80	18.00	18.20	A1				
	21.75	22.00	22.25	E5		18.40		18.80	E5				
20 x 18	20.80		21.35	B1	x	18.80		19.20	B1	150	12 5/8 x 11	7	\$ 2,480.92
	21.35	21.60	21.75	A2		19.10	19.50	19.70	A2				
	21.75	22.00	22.25	E5		19.70	20.00	20.25	E5				
22 x 16	22.95		23.35	B1	x	17.40	17.40	17.80	B2	150	13 5/8 x 11	7	\$ 2,905.47
	23.45		23.85	A2		17.80	18.00	18.20	A1				
	23.75	24.00	24.25	E5		18.40		18.80	E5				
22 x 18	22.95		23.35	B1	x	18.80		19.20	B1	150	13 5/8 x 11	7	\$ 2,891.86
	23.45		23.85	A2		19.10	19.50	19.70	A2				
	23.75	24.00	24.25	E5		19.70	20.00	20.25	E5				
22 x 20	22.95		23.35	B1	x	20.80		21.35	B1	150	13 5/8 x 11	7	\$ 2,658.81
	23.45		23.85	A2		21.35	21.60	21.75	A2				
	23.75	24.00	24.25	E5		21.75	22.00	22.25	E5				
24 x 22	25.70	25.80	26.00	A2	x	22.95		23.35	B1	150	14 5/8 x 15	10	\$ 3,442.10
	26.10		26.32	E5		23.45		23.85	A2				
						23.75	24.00	24.25	E5				

All dimensions are in inches

Note: * The high limit of the range is used in the ordering code.

ROBAR INDUSTRIES LTD.

BC Phone (604) 591-8811 / 1-800-663-6553
Fax (604) 591-5288
Email: waterworks@robarindustries.com

LES PRODUITS INDUSTRIELS ROBAR INC.

QUEBEC Phone (450) 441-7525 / 1-800-315-9525
Fax (450) 441-4894
Web www.Robairindustries.com



1507R REDUCING COUPLINGS

CAST DUCTILE IRON

PRICE INFORMATION

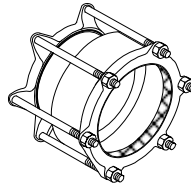

Nom Pipe Size	First End				By X	Second End				MAX. Press. (LBS/IN)	Fasteners No. Dia x Length	Sleeve Length (IN.)	List Price
	Range			End Code		Range			End Code				
	Low	Pipe OD Actual	High*			Low	Pipe OD Actual	High*					
6 x 4	5.85		6.15	F3A	x	3.45	3.50	3.60	4T	300	5 5/8 x 8	5	\$461.13
	6.15		6.45	F3B		3.75		4.05	F3A				
	6.50	6.63	6.70	D3		4.05		4.35	F3B				
	6.86	6.90	7.10	A1		4.40	4.50	4.60	D3				
	7.15		7.35	E5		4.74	4.80	5.10	A1				
						5.10		5.30	E5				
8 x 6	7.90		8.25	F3A	x	5.85		6.15	F3A	300	6 5/8 x 8	5	\$586.81
	8.25		8.55	F3B		6.15		6.45	F3B				
	8.55	8.63	8.75	D3		6.50	6.63	6.70	D3				
	8.99	9.05	9.30	A1		6.86	6.90	7.10	A1				
	9.30		9.50	E5		7.15		7.35	E5				
10 x 8	9.85		10.20	F4A	x	7.90		8.25	F3A	300	7 5/8 x 11	7	\$903.80
	10.20		10.50	F4B		8.25		8.55	F3B				
	10.60	10.75	10.90	D4		8.55	8.63	8.75	D3				
	11.10	11.10	11.40	B2		8.99	9.05	9.30	A1				
	11.55		11.75	A1		9.30		9.50	E5				
	11.90		12.10	E5									
12 x 10	12.00		12.30	F4A	x	9.85		10.20	F4A	300	8 5/8 x 11	7	\$1,026.83
	12.30		12.60	F4B		10.20		10.50	F4B				
	12.60	12.75	12.90	D4		10.60	10.75	10.90	D4				
	13.20	13.20	13.60	B2		11.10	11.10	11.40	B2				
	13.80	14.00	14.10	A1		11.55		11.75	A1				
	14.10		14.35	E5		11.90		12.10	E5				
14 x 12	14.60		14.90	F2	x	12.00		12.30	F4A	150	9 5/8 x 11	7	\$1,562.79
	15.30	15.30	15.70	B2		12.30		12.60	F4B				
	15.80	16.00	16.25	A1		12.60	12.75	12.90	D4				
	16.40		16.80	E5		13.20	13.20	13.60	B2				
						13.80	14.00	14.10	A1				
						14.10		14.35	E5				

All dimensions are in inches

Note: * The high limit of the range is used in the ordering code.

ROBAR INDUSTRIES LTD.

BC Phone (604) 591-8811 / 1-800-663-6553
 Fax (604) 591-5288
 Email: waterworks@robarindustries.com

LES PRODUITS INDUSTRIELS ROBAR INC.

QUEBEC Phone (450) 441-7525 / 1-800-315-9525
 Fax (450) 441-4894
 Web www.Robarindustries.com

1507R REDUCING COUPLINGS

CAST DUCTILE IRON
PRICE INFORMATION

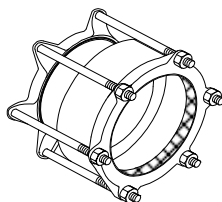

Nom Pipe Size	FIRST END				By X	SECOND END				MAX. PRESS. (LBS/IN ²)	Fasteners No. Dia x Length	Sleeve Length (IN.)	List Price
	RANGE					RANGE							
	Low	Pipe OD Actual	High*	End Code		Low	Pipe OD Actual	High*	End Code				
16 x 14					x	14.60		14.90	F2	150	10 5/8 x 11	7	\$ 1,881.86
	17.40	17.40	17.80	B2		15.30	15.30	15.70	B2				
	17.80	18.00	18.20	A1		15.80	16.00	16.25	A1				
	18.40		18.80	E5		16.40		16.80	E5				
18 x 16	18.80		19.20	B1	x	17.40	17.40	17.80	B2	150	12 5/8 x 11	7	\$ 2,317.68
	19.10	19.50	19.70	A2		17.80	18.00	18.20	A1				
	19.70	20.00	20.25	E5		18.40		18.80	E5				
20 x 16	20.80		21.35	B1	x	17.40	17.40	17.80	B2	150	12 5/8 x 11	7	\$ 2,659.88
	21.35	21.60	21.75	A2		17.80	18.00	18.20	A1				
	21.75	22.00	22.25	E5		18.40		18.80	E5				
20 x 18	20.80		21.35	B1	x	18.80		19.20	B1	150	12 5/8 x 11	7	\$ 2,571.14
	21.35	21.60	21.75	A2		19.10	19.50	19.70	A2				
	21.75	22.00	22.25	E5		19.70	20.00	20.25	E5				
22 x 16	22.95		23.35	B1	x	17.40	17.40	17.80	B2	150	13 5/8 x 11	7	\$ 3,003.23
	23.45		23.85	A2		17.80	18.00	18.20	A1				
	23.75	24.00	24.25	E5		18.40		18.80	E5				
22 x 18	22.95		23.35	B1	x	18.80		19.20	B1	150	13 5/8 x 11	7	\$ 2,989.63
	23.45		23.85	A2		19.10	19.50	19.70	A2				
	23.75	24.00	24.25	E5		19.70	20.00	20.25	E5				
22 x 20	22.95		23.35	B1	x	20.80		21.35	B1	150	13 5/8 x 11	7	\$ 2,739.32
	23.45		23.85	A2		21.35	21.60	21.75	A2				
	23.75	24.00	24.25	E5		21.75	22.00	22.25	E5				
24 x 22	25.70	25.80	26.00	A2	x	22.95		23.35	B1	150	14 5/8 x 15	10	\$ 3,244.56
	26.10		26.32	E5		23.45		23.85	A2				
						23.75	24.00	24.25	E5				

All dimensions are in inches

Note: * The high limit of the range is used in the ordering code.

ROBAR INDUSTRIES LTD.

BC Phone (604) 591-8811 / 1-800-663-6553
Fax (604) 591-5288
Email: waterworks@robarindustries.com

LES PRODUITS INDUSTRIELS ROBAR INC.

QUEBEC Phone (450) 441-7525 / 1-800-315-9525
Fax (450) 441-4894
Web www.Robarindustries.com



1508R REDUCING COUPLINGS

CAST DUCTILE IRON
PRICE INFORMATION

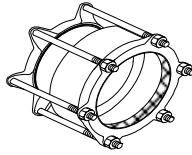

Nom Pipe Size	First End				By X	Second End				MAX. Press. (LBS/IN)	Fasteners No. Dia x Length	Sleeve Length (IN.)	List Price
	Range			End Code		Range			End Code				
	Low	Pipe OD Actual	High*			Low	Pipe OD Actual	High*					
6 x 4	5.85		6.15	F3A	x	3.45	3.50	3.60	4T	300	5 5/8 x 8	5	\$342.53
	6.15		6.45	F3B		3.75		4.05	F3A				
	6.50	6.63	6.70	D3		4.05		4.35	F3B				
	6.86	6.90	6.70	A1		4.40	4.50	4.60	D3				
	7.15		7.35	E5		4.74	4.80	5.10	A1				
						5.10		5.30	E5				
8 x 6	7.90		8.25	F3A	x	5.85		6.15	F3A	300	6 5/8 x 8	5	\$443.34
	8.25		8.55	F3B		6.15		6.45	F3B				
	8.55	8.63	8.75	D3		6.50	6.63	6.70	D3				
	8.99	9.05	9.30	A1		6.86	6.90	6.70	A1				
	9.30		9.50	E5		7.15		7.35	E5				
10 x 8	9.85		10.20	F4A	x	7.90		8.25	F3A	300	7 5/8 x 11	7	\$727.77
	10.20		10.50	F4B		8.25		8.55	F3B				
	10.60	10.75	10.90	D4		8.55	8.63	8.75	D3				
	11.10	11.10	11.40	B2		8.99	9.05	9.30	A1				
	11.55		11.75	A1		9.30		9.50	E5				
	11.90		12.10	E5									
12 x 10	12.00		12.30	F4A	x	9.85		10.20	F4A	300	8 5/8 x 11	7	\$825.26
	12.30		12.60	F4B		10.20		10.50	F4B				
	12.60	12.75	12.90	D4		10.60	10.75	10.90	D4				
	13.20	13.20	13.60	B2		11.10	11.10	11.40	B2				
	13.80	14.00	14.10	A1		11.55		11.75	A1				
	14.10		14.35	E5		11.90		12.10	E5				
14 x 12	14.60		14.90	F2	x	12.00		12.30	F4A	150	9 5/8 x 11	7	\$1,322.01
	15.30	15.30	15.70	B2		12.30		12.60	F4B				
	15.80	16.00	16.25	A1		12.60	12.75	12.90	D4				
	16.40		16.80	E5		13.20	13.20	13.60	B2				
						13.80	14.00	14.10	A1				
						14.10		14.35	E5				

All dimensions are in inches
Continued....

Note: * The high limit of the range is used in the ordering code.

ROBAR INDUSTRIES LTD.

BC Phone (604) 591-8811 / 1-800-663-6553
Fax (604) 591-5288
Email: waterworks@robarindustries.com

LES PRODUITS INDUSTRIELS ROBAR INC.

QUEBEC Phone (450) 441-7525 / 1-800-315-9525
Fax (450) 441-4894
Web www.Robarindustries.com



1508R REDUCING COUPLINGS

CAST DUCTILE IRON
PRICE INFORMATION

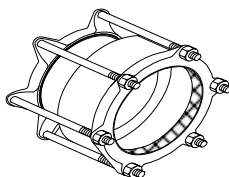

Nom Pipe Size	First End				By X	Second End				MAX. Press. (LBS/IN)	Fasteners No. Dia x Length	Sleeve Length (IN.)	List Price
	Range					Range							
	Low	Pipe OD Actual	High*	End Code		Low	Pipe OD Actual	High*	End Code				
16 x 14	17.40	17.40	17.80	B2	x	14.60		14.90	F2	150	10 5/8 x 11	7	\$ 1,590.42
	17.80	18.00	18.20	A1		15.30	15.30	15.70	B2				
	18.40		18.80	E5		15.80	16.00	16.25	A1				
						16.40		16.80	E5				
18 x 16	18.80		19.20	B1	x	17.40	17.40	17.80	B2	150	12 5/8 x 11	7	\$ 2,035.11
	19.10	19.50	19.70	A2		17.80	18.00	18.20	A1				
	19.70	20.00	20.25	E5		18.40		18.80	E5				
20 x 16	20.80		21.35	B1	x	17.40	17.40	17.80	B2	150	12 5/8 x 11	7	\$ 2,296.83
	21.35	21.60	21.75	A2		17.80	18.00	18.20	A1				
	21.75	22.00	22.25	E5		18.40		18.80	E5				
20 x 18	20.80		21.35	B1	x	18.80		19.20	B1	150	12 5/8 x 11	7	\$ 2,210.03
	21.35	21.60	21.75	A2		19.10	19.50	19.70	A2				
	21.75	22.00	22.25	E5		19.70	20.00	20.25	E5				
22 x 16	22.95		23.35	B1	x	17.40	17.40	17.80	B2	150	13 5/8 x 11	7	\$ 2,605.30
	23.45		23.85	A2		17.80	18.00	18.20	A1				
	23.75	24.00	24.25	E5		18.40		18.80	E5				
22 x 18	22.95		23.35	B1	x	18.80		19.20	B1	150	13 5/8 x 11	7	\$ 2,591.95
	23.45		23.85	A2		19.10	19.50	19.70	A2				
	23.75	24.00	24.25	E5		19.70	20.00	20.25	E5				
22 x 20	22.95		23.35	B1	x	20.80		21.35	B1	150	13 5/8 x 11	7	\$ 2,367.61
	23.45		23.85	A2		21.35	21.60	21.75	A2				
	23.75	24.00	24.25	E5		21.75	22.00	22.25	E5				
24 x 22	25.70	25.80	26.00	A2	x	22.95		23.35	B1	150	14 5/8 x 15	10	\$ 2,790.92
	26.10		26.32	E5		23.45		23.85	A2				
						23.75	24.00	24.25	E5				

All dimensions are in inches

Note: * The high limit of the range is used in the ordering code.

ROBAR INDUSTRIES LTD.

BC Phone (604) 591-8811 / 1-800-663-6553
Fax (604) 591-5288
Email: waterworks@robarindustries.com

LES PRODUITS INDUSTRIELS ROBAR INC.

QUEBEC Phone (450) 441-7525 / 1-800-315-9525
Fax (450) 441-4894
Web www.Robarindustries.com



1519R REDUCING COUPLINGS

CAST DUCTILE IRON
PRICE INFORMATION

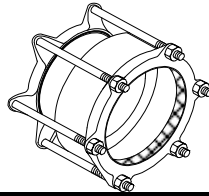

Nom Pipe Size	First End				By X	Second End				MAX. Press. (LBS/IN)	Fasteners No. Dia x Length	Sleeve Length (IN.)	List Price
	Range					Range							
	Low	Pipe OD Actual	High*	End Code		Low	Pipe OD Actual	High*	End Code				
6 x 4	5.85		6.15	F3A	x	3.45	3.50	3.60	4T	300	5 5/8 x 8	5	\$387.44
	6.15		6.45	F3B		3.75		4.05	F3A				
	6.50	6.63	6.70	D3		4.05		4.35	F3B				
	6.86	6.90	6.70	A1		4.40	4.50	4.60	D3				
	7.15		7.35	E5		4.74	4.80	5.10	A1				
						5.10		5.30	E5				
8 x 6	7.90		8.25	F3A	x	5.85		6.15	F3A	300	6 5/8 x 8	5	\$497.22
	8.25		8.55	F3B		6.15		6.45	F3B				
	8.55	8.63	8.75	D3		6.50	6.63	6.70	D3				
	8.99	9.05	9.30	A1		6.86	6.90	6.70	A1				
	9.30		9.50	E5		7.15		7.35	E5				
10 x 8	9.85		10.20	F4A	x	7.90		8.25	F3A	300	7 5/8 x 11	7	\$798.00
	10.20		10.50	F4B		8.25		8.55	F3B				
	10.60	10.75	10.90	D4		8.55	8.63	8.75	D3				
	11.10	11.10	11.40	B2		8.99	9.05	9.30	A1				
	11.55		11.75	A1		9.30		9.50	E5				
	11.90		12.10	E5									
12 x 10	12.00		12.30	F4A	x	9.85		10.20	F4A	300	8 5/8 x 11	7	\$899.68
	12.30		12.60	F4B		10.20		10.50	F4B				
	12.60	12.75	12.90	D4		10.60	10.75	10.90	D4				
	13.20	13.20	13.60	B2		11.10	11.10	11.40	B2				
	13.80	14.00	14.10	A1		11.55		11.75	A1				
	14.10		14.35	E5		11.90		12.10	E5				
14 x 12	14.60		14.90	F2	x	12.00		12.30	F4A	150	9 5/8 x 11	7	\$1,419.57
	15.30	15.30	15.70	B2		12.30		12.60	F4B				
	15.80	16.00	16.25	A1		12.60	12.75	12.90	D4				
	16.40		16.80	E5		13.20	13.20	13.60	B2				
						13.80	14.00	14.10	A1				
						14.10		14.35	E5				

All dimensions are in inches
Continued....

Note: * The high limit of the range is used in the ordering code.

ROBAR INDUSTRIES LTD.

BC Phone (604) 591-8811 / 1-800-663-6553
Fax (604) 591-5288
Email: waterworks@robarindustries.com

LES PRODUITS INDUSTRIELS ROBAR INC.

QUEBEC Phone (450) 441-7525 / 1-800-315-9525
Fax (450) 441-4894
Web www.Robarindustries.com

1519R REDUCING COUPLINGS

CAST DUCTILE IRON
PRICE INFORMATION

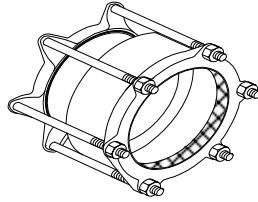

Nom Pipe Size	First End				By X	Second End				MAX. Press. (LBS/IN)	Fasteners No. Dia x Length	Sleeve Length (IN.)	List Price
	Range			End Code		Range			End Code				
	Low	Pipe OD Actual	High*			Low	Pipe OD Actual	High*					
16 x 14						14.60		14.90	F2	150	10 5/8 x 11	7	\$ 1,708.99
	17.40	17.40	17.80	B2	x	15.30	15.30	15.70	B2				
	17.80	18.00	18.20	A1		15.80	16.00	16.25	A1				
	18.40		18.80	E5		16.40		16.80	E5				
18 x 16	18.80		19.20	B1		17.40	17.40	17.80	B2	150	12 5/8 x 11	7	\$ 2,110.47
	19.10	19.50	19.70	A2	x	17.80	18.00	18.20	A1				
	19.70	20.00	20.25	E5		18.40		18.80	E5				
20 x 16	20.80		21.35	B1		17.40	17.40	17.80	B2	150	12 5/8 x 11	7	\$ 2,452.67
	21.35	21.60	21.75	A2	x	17.80	18.00	18.20	A1				
	21.75	22.00	22.25	E5		18.40		18.80	E5				
20 x 18	20.80		21.35	B1		18.80		19.20	B1	150	12 5/8 x 11	7	\$ 2,370.35
	21.35	21.60	21.75	A2	x	19.10	19.50	19.70	A2				
	21.75	22.00	22.25	E5		19.70	20.00	20.25	E5				
22 x 16	22.95		23.35	B1		17.40	17.40	17.80	B2	150	13 5/8 x 11	7	\$ 2,785.15
	23.45		23.85	A2	x	17.80	18.00	18.20	A1				
	23.75	24.00	24.25	E5		18.40		18.80	E5				
22 x 18	22.95		23.35	B1		18.80		19.20	B1	150	13 5/8 x 11	7	\$ 2,771.58
	23.45		23.85	A2	x	19.10	19.50	19.70	A2				
	23.75	24.00	24.25	E5		19.70	20.00	20.25	E5				
22 x 20	22.95		23.35	B1		20.80		21.35	B1	150	13 5/8 x 11	7	\$ 2,521.08
	23.45		23.85	A2	x	21.35	21.60	21.75	A2				
	23.75	24.00	24.25	E5		21.75	22.00	22.25	E5				
24 x 22	25.70	25.80	26.00	A2		22.95		23.35	B1	150	14 5/8 x 15	10	\$ 3,009.18
	26.10		26.32	E5	x	23.45		23.85	A2				
						23.75	24.00	24.25	E5				

All dimensions are in inches

Note: * The high limit of the range is used in the ordering code.

ROBAR INDUSTRIES LTD.

BC Phone (604) 591-8811 / 1-800-663-6553
Fax (604) 591-5288
Email: waterworks@robarindustries.com

LES PRODUITS INDUSTRIELS ROBAR INC.

QUEBEC Phone (450) 441-7525 / 1-800-315-9525
Fax (450) 441-4894
Web www.Robarindustries.com



1406 & 1408 COUPLING COMPONENTS

PRICE INFORMATION

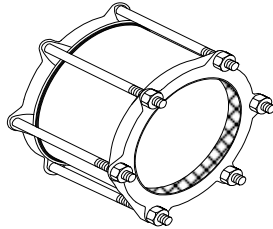

Nominal Pipe Size	Center Sleeve Description	Center Sleeve Length	Center Sleeve Price	End Ring Price	Gasket Price
4	Standard	5"	\$ 35.57	\$ 17.58	\$ 8.96
	Long Body	7"	\$ 57.03	\$ 17.58	\$ 8.96
6	Standard	5"	\$ 61.13	\$ 24.99	\$ 10.88
	Long Body	7"	\$ 85.82	\$ 24.99	\$ 10.88
8	Standard	5"	\$ 64.03	\$ 37.57	\$ 16.70
	Long Body	7"	\$ 96.37	\$ 37.57	\$ 16.70
10	Standard	7"	\$ 179.55	\$ 58.66	\$ 22.78
	G8 and S9	7"	\$ 132.05	\$ 53.99	\$ 17.94
12	Standard	7"	\$ 189.04	\$ 67.23	\$ 33.09
	G8 and S9	7"	\$ 139.38	\$ 57.77	\$ 25.67
14	Standard	7"	\$ 327.43	\$ 123.23	\$ 69.52
16	Standard	7"	\$ 359.49	\$ 150.87	\$ 73.15
18	Standard	7"	\$ 492.60	\$ 204.63	\$ 83.78
20	Standard	7"	\$ 611.25	\$ 278.10	\$ 86.86
22	Standard	7"	\$ 733.39	\$ 288.50	\$ 88.66
24	Standard	10"	\$ 749.93	\$ 331.70	\$ 98.86

Note: For Fasteners Prices see page 1 - 31

ROBAR INDUSTRIES LTD.

BC Phone (604) 591-8811 / 1-800-663-6553
 Fax (604) 591-5288
 Email waterworks@robarindustries.com

LES PRODUITS INDUSTRIELS ROBAR INC.

QUEBEC Phone (450) 441-7525 / 1-800-315-9525
 Fax (450) 441-4894
 Web www.Robarindustries.com



1506 & 1508 COUPLING COMPONENTS

PRICE INFORMATION

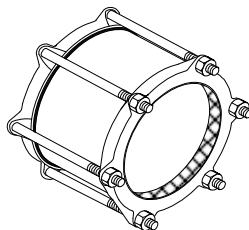

Nominal Pipe Size	Center Sleeve Description	Center Sleeve Length	Center Sleeve Price	End Ring Price	Gasket Price
4	Standard	5"	\$ 56.87	\$ 28.07	\$ 8.96
	Long Body	7"	\$ 91.27	\$ 28.07	\$ 8.96
6	Standard	5"	\$ 97.78	\$ 39.95	\$ 10.88
	Long Body	7"	\$ 137.31	\$ 39.95	\$ 10.88
8	Standard	5"	\$ 102.40	\$ 60.12	\$ 16.70
	Long Body	7"	\$ 154.16	\$ 60.12	\$ 16.70
10	Standard	7"	\$ 251.37	\$ 82.15	\$ 22.78
	G8 and S9	7"	\$ 191.46	\$ 78.31	\$ 17.94
12	Standard	7"	\$ 264.63	\$ 94.17	\$ 33.09
	G8 and S9	7"	\$ 202.06	\$ 83.81	\$ 25.67
14	Standard	7"	\$ 491.15	\$ 184.81	\$ 69.52
16	Standard	7"	\$ 521.27	\$ 218.74	\$ 73.15
18	Standard	7"	\$ 640.42	\$ 266.02	\$ 83.78
20	Standard	7"	\$ 733.45	\$ 333.68	\$ 86.86
22	Standard	7"	\$ 880.09	\$ 345.94	\$ 88.66
24	Standard	10"	\$ 899.97	\$ 396.84	\$ 98.86

Note: For Fasteners Prices see page 1 - 31

ROBAR INDUSTRIES LTD.

BC Phone (604) 591-8811 / 1-800-663-6553
 Fax (604) 591-5288
 Email waterworks@robarindustries.com

LES PRODUITS INDUSTRIELS ROBAR INC.

QUEBEC Phone (450) 441-7525 / 1-800-315-9525
 Fax (450) 441-4894
 Web www.Robarindustries.com



1507 & 1519 COUPLING COMPONENTS

PRICE INFORMATION

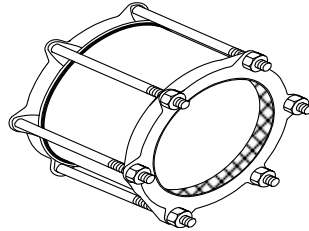

Nominal Pipe Size	Center Sleeve Description	Center Sleeve Length	1507 Center Sleeve Price	1519 Center Sleeve Price	End Ring Price	Gasket Price
4	Standard	5"	\$ 56.87	\$ 62.65	\$ 30.86	\$ 8.96
	Long Body	7"	\$ 91.27	\$ 97.01	\$ 30.86	\$ 8.96
6	Standard	5"	\$ 97.78	\$ 103.56	\$ 43.43	\$ 10.88
	Long Body	7"	\$ 137.31	\$ 143.06	\$ 43.43	\$ 10.88
8	Standard	5"	\$ 102.40	\$ 115.07	\$ 64.20	\$ 16.70
	Long Body	7"	\$ 154.16	\$ 129.18	\$ 64.20	\$ 16.70
10	Standard	7"	\$ 251.37	\$ 257.15	\$ 86.95	\$ 22.78
	G8 and S9	7"	\$ 191.46	\$ 197.20	\$ 83.15	\$ 17.94
12	Standard	7"	\$ 264.63	\$ 270.38	\$ 99.69	\$ 33.09
	G8 and S9	7"	\$ 202.06	\$ 207.85	\$ 89.30	\$ 25.67
14	Standard	7"	\$ 491.15	\$ 497.39	\$ 191.57	\$ 69.52
16	Standard	7"	\$ 521.27	\$ 527.52	\$ 226.26	\$ 73.15
18	Standard	7"	\$ 640.42	\$ 646.64	\$ 275.03	\$ 83.78
20	Standard	7"	\$ 733.45	\$ 739.71	\$ 342.73	\$ 86.86
22	Standard	7"	\$ 880.09	\$ 886.36	\$ 355.67	\$ 88.66
24	Standard	10"	\$ 899.97	\$ 906.19	\$ 408.52	\$ 98.86

Note: For Fasteners Prices see page 1 - 31

ROBAR INDUSTRIES LTD.

BC Phone (604) 591-8811 / 1-800-663-6553
 Fax (604) 591-5288
 Email waterworks@robarindustries.com

LES PRODUITS INDUSTRIELS ROBAR INC

QUEBEC Phone (450) 441-7525/1-800-315-9525
 Fax (450) 441-4894
 Web www.Robarindustries.com

1406R and 1408R REDUCING COUPLING COMPONENTS

PRICE INFORMATION

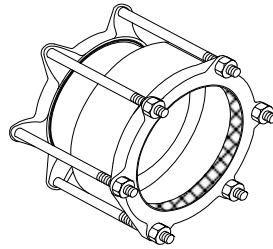

Nominal Pipe Size	Center Sleeve Description	Center Sleeve Price	Large End Ring Price	Small End Ring Price	Large Gasket Price	Small Gasket Price
6 x 4	6" Standard x 4" Standard	\$ 81.23	\$ 24.99	\$ 74.97	\$ 10.88	\$ 8.96
8 x 6	8" Standard x 6" Standard	\$ 108.66	\$ 37.57	\$ 89.09	\$ 16.70	\$ 10.88
10 x 8	10" Steel x 8" Standard	\$ 230.54	\$ 58.66	\$ 117.96	\$ 22.78	\$ 16.70
	10" Standard x 8" Standard	\$ 230.54	\$ 58.66	\$ 117.96	\$ 22.78	\$ 16.70
10 x 10	10" Standard x 10" Steel	\$ 179.55	\$ 58.66	\$ 58.66	\$ 22.78	\$ 22.78
12 x 10	12" Steel x 10" Steel	\$ 263.14	\$ 67.23	\$ 124.76	\$ 33.09	\$ 22.78
	12" Steel x 10" Standard	\$ 263.14	\$ 67.23	\$ 124.76	\$ 33.09	\$ 22.78
	12" Standard x 10" Steel	\$ 263.14	\$ 67.23	\$ 124.76	\$ 33.09	\$ 22.78
	12" Standard x 10" Standard	\$ 263.14	\$ 67.23	\$ 124.76	\$ 33.09	\$ 22.78
12 x 12	12" Standard x 12" Steel	\$ 189.04	\$ 67.23	\$ 67.23	\$ 33.09	\$ 33.09
14 x 12	14" Standard x 12" Standard	\$ 419.88	\$ 123.23	\$ 202.40	\$ 69.52	\$ 33.09
16 x 14	16" Standard x 14" Standard	\$ 472.29	\$ 150.87	\$ 251.66	\$ 73.15	\$ 69.52
18 x 16	18" Standard x 16" Standard	\$ 634.38	\$ 204.63	\$ 277.18	\$ 83.78	\$ 73.15
20 x 16	20" Standard x 16" Standard	\$ 753.77	\$ 278.10	\$ 321.14	\$ 86.86	\$ 73.15
20 x 18	20" Standard x 18" Standard	\$ 700.88	\$ 278.10	\$ 314.22	\$ 86.86	\$ 83.78
22 x 16	22" Standard x 16" Standard	\$ 936.90	\$ 288.50	\$ 318.46	\$ 86.86	\$ 73.15
22 x 18	22" Standard x 18" Standard	\$ 911.13	\$ 288.50	\$ 329.33	\$ 88.66	\$ 83.78
22 x 20	22" Standard x 20" Standard	\$ 728.88	\$ 288.50	\$ 329.33	\$ 88.66	\$ 86.86
24 x 22	24" Standard x 22" Standard	\$ 841.10	\$ 331.69	\$ 451.74	\$ 98.86	\$ 88.66

Note: For Fasteners Prices see page 1 - 31

ROBAR INDUSTRIES LTD.

BC Phone (604) 591-8811 / 1-800-663-6553
 Fax (604) 591-5288
 Email: waterworks@robarindustries.com

LES PRODUITS INDUSTRIELS ROBAR INC.

QUEBEC Phone (450) 441-7525 / 1-800-315-9525
 Fax (450) 441-4894
 Web www.Robarindustries.com



1506R and 1508R REDUCING COUPLING COMPONENTS PRICE INFORMATION

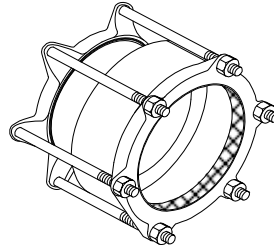

Nominal Pipe Size	Center Sleeve Description	Center Sleeve Price	Large End Ring Price	Small End Ring Price	Large Gasket Price	Small Gasket Price
6 x 4	6" Standard x 4" Standard	\$ 129.96	\$ 39.95	\$ 127.09	\$ 10.88	\$ 8.96
8 x 6	8" Standard x 6" Standard	\$ 173.88	\$ 60.19	\$ 146.83	\$ 16.70	\$ 10.88
10 x 8	10" Steel x 8" Standard	\$ 368.86	\$ 82.15	\$ 194.34	\$ 22.78	\$ 16.70
	10" Standard x 8" Standard	\$ 368.86	\$ 82.15	\$ 194.34	\$ 22.78	\$ 16.70
10 x 10	10" Standard x 10" Steel	\$ 251.37	\$ 82.15	\$ 84.62	\$ 22.78	\$ 22.78
12 x 10	12" Steel x 10" Steel	\$ 421.01	\$ 94.17	\$ 209.57	\$ 33.09	\$ 22.78
	12" Steel x 10" Standard	\$ 421.01	\$ 94.17	\$ 205.65	\$ 33.09	\$ 22.78
	12" Standard x 10" Steel	\$ 421.01	\$ 94.17	\$ 205.65	\$ 33.09	\$ 22.78
	12" Standard x 10" Standard	\$ 421.01	\$ 94.17	\$ 205.65	\$ 33.09	\$ 22.78
12 x 12	12" Standard x 12" Steel	\$ 264.63	\$ 94.17	\$ 97.01	\$ 33.09	\$ 33.09
14 x 12	14" Standard x 12" Standard	\$ 660.50	\$ 184.81	\$ 333.56	\$ 69.52	\$ 33.09
16 x 14	16" Standard x 14" Standard	\$ 755.61	\$ 218.74	\$ 414.77	\$ 73.15	\$ 69.52
18 x 16	18" Standard x 16" Standard	\$ 1,015.04	\$ 266.02	\$ 456.81	\$ 83.78	\$ 73.15
20 x 16	20" Standard x 16" Standard	\$ 1,206.04	\$ 333.68	\$ 529.21	\$ 86.86	\$ 73.15
20 x 18	20" Standard x 18" Standard	\$ 1,120.33	\$ 333.68	\$ 517.88	\$ 86.86	\$ 83.78
22 x 16	22" Standard x 16" Standard	\$ 1,499.00	\$ 345.94	\$ 524.81	\$ 86.86	\$ 73.15
22 x 18	22" Standard x 18" Standard	\$ 1,457.82	\$ 345.94	\$ 542.75	\$ 88.66	\$ 83.78
22 x 20	22" Standard x 20" Standard	\$ 1,166.18	\$ 345.94	\$ 606.81	\$ 88.66	\$ 86.86
24 x 22	24" Standard x 22" Standard	\$ 1,345.78	\$ 396.84	\$ 744.45	\$ 98.86	\$ 88.66

Note: For Fasteners Prices see page 1 - 31

ROBAR INDUSTRIES LTD.

BC Phone (604) 591-8811 / 1-800-663-6553
 Fax (604) 591-5288
 Email: waterworks@robarindustries.com

LES PRODUITS INDUSTRIELS ROBAR INC.

QUEBEC Phone (450) 441-7525 / 1-800-315-9525
 Fax (450) 441-4894
 Web: www.Robarindustries.com



1507R / 1519R

REDUCING COUPLING COMPONENTS

PRICE INFORMATION

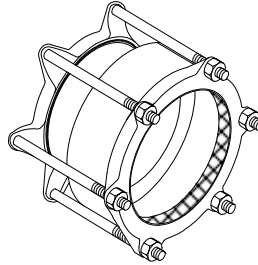

Nominal Pipe Size	Center Sleeve Description	Center Sleeve Price	Large End Ring Price	Small End Ring Price	Large Gasket Price	Small Gasket Price
6 x 4	6" Standard x 4" Standard	\$ 129.97	\$ 39.95	\$ 127.10	\$ 10.88	\$ 8.96
8 x 6	8" Standard x 6" Standard	\$ 173.88	\$ 60.19	\$ 146.82	\$ 16.70	\$ 10.88
10 x 8	10" Steel x 8" Standard	\$ 368.86	\$ 82.15	\$ 194.34	\$ 22.78	\$ 16.70
	10" Standard x 8" Standard	\$ 368.86	\$ 82.15	\$ 194.34	\$ 22.78	\$ 16.70
10 x 10	10" Standard x 10" Steel	\$ 251.37	\$ 82.15	\$ 84.62	\$ 22.78	\$ 22.78
12 x 10	12" Steel x 10" Steel	\$ 421.01	\$ 94.17	\$ 209.56	\$ 33.09	\$ 22.78
	12" Steel x 10" Standard	\$ 421.01	\$ 94.17	\$ 205.64	\$ 33.09	\$ 22.78
	12" Standard x 10" Steel	\$ 421.01	\$ 94.17	\$ 205.64	\$ 33.09	\$ 22.78
	12" Standard x 10" Standard	\$ 421.01	\$ 94.17	\$ 205.64	\$ 33.09	\$ 22.78
12 x 12	12" Standard x 12" Steel	\$ 264.63	\$ 94.17	\$ 97.01	\$ 33.09	\$ 33.09
14 x 12	14" Standard x 12" Standard	\$ 660.50	\$ 184.81	\$ 333.56	\$ 69.52	\$ 33.09
16 x 14	16" Standard x 14" Standard	\$ 755.60	\$ 218.74	\$ 414.78	\$ 73.15	\$ 69.52
18 x 16	18" Standard x 16" Standard	\$ 1,015.04	\$ 266.03	\$ 456.81	\$ 83.78	\$ 73.15
20 x 16	20" Standard x 16" Standard	\$ 1,206.04	\$ 333.68	\$ 529.21	\$ 86.86	\$ 73.15
20 x 18	20" Standard x 18" Standard	\$ 1,120.33	\$ 333.68	\$ 517.88	\$ 86.86	\$ 83.78
22 x 16	22" Standard x 16" Standard	\$ 1,499.00	\$ 345.93	\$ 524.81	\$ 86.86	\$ 73.15
22 x 18	22" Standard x 18" Standard	\$ 1,457.82	\$ 345.93	\$ 542.75	\$ 88.66	\$ 83.78
22 x 20	22" Standard x 20" Standard	\$ 1,166.18	\$ 345.93	\$ 606.81	\$ 88.66	\$ 86.86
24 x 20	24" Standard x 22" Standard	\$ 1,345.78	\$ 396.84	\$ 745.52	\$ 98.86	\$ 88.66

Note: For Fasteners Prices see page 1 - 31

ROBAR INDUSTRIES LTD.

BC Phone (604) 591-8811 / 1-800-663-6553
 Fax (604) 591-5288
 Email: waterworks@robarindustries.com

LES PRODUITS INDUSTRIELS ROBAR INC.

QUEBEC Phone (450) 441-7525 / 1-800-315-9525
 Fax (450) 441-4894
 Web: www.Robarindustries.com

1406, 1408, 1506, 1507, 1508 & 1519 FASTENERS

PRICE INFORMATION

1406 & 1506 Coupling Fasteners - T-304 Stainless Steel

Description	Price
5/8" NC x 8" SS TRACKHEAD BOLTS	\$ 16.83
5/8" NC x 11" SS TRACKHEAD BOLTS	\$ 17.87
5/8" NC x 14" SS TRACKHEAD BOLTS	\$ 24.78
5/8" NC x 15" SS TRACKHEAD BOLTS	\$ 26.55
5/8" NC SS HEAVY HEX NUTS	\$ 2.07
5/8" SS WASHERS	\$ 0.53

1408 & 1508 Coupling Fasteners - Low Alloy Steel

Description	Price
5/8" NC x 8" TRACKHEAD BOLTS	\$ 5.98
5/8" NC x 11" TRACKHEAD BOLTS	\$ 6.41
5/8" NC x 14" TRACKHEAD BOLTS	\$ 9.06
5/8" NC x 15" TRACKHEAD BOLTS	\$ 9.71
5/8" NC HEAVY HEX NUTS	\$ 0.86

1507 & 1519 Coupling Fasteners - Epoxy Coated Low Alloy Steel

Description	Price
5/8" NC x 8" COATED TRACKHEAD BOLTS	\$ 9.60
5/8" NC x 11" COATED TRACKHEAD BOLTS	\$ 11.81
5/8" NC x 14" COATED TRACKHEAD BOLTS	\$ 16.01
ANODES 300G	\$ 13.39
3/4" x 9" T-304 SS TAPPING SLEEVE BOLTS	\$ 30.33
3/4" SS HEAVY HEX NUT	\$ 3.73
3/4" SS WASHER	\$ 1.31
3/4" x 9" MILD STEEL TAPPING SLEEVE BOLTS	\$ 10.22
3/4" MILD STEEL HEAVY HEX NUT	\$ 1.41

ROBAR INDUSTRIES LTD.

BC Phone (604) 591-8811 / 1-800-663-6553
 Fax (604) 591-5288
 Email: waterworks@robarindustries.com

LES PRODUITS INDUSTRIELS ROBAR INC.

QUEBEC Phone (450) 441-7525 / 1-800-315-9525
 Fax (450) 441-4894
 Web: www.Robarindustries.com



2 Bolt All Stainless Steel Coupling

1696-2B

PRICING INFORMATION

1696 - 2B Coupling

Nominal Size	Weight Lbs.	List Price
4"	17	\$ 444.20
6"	21	\$ 515.04
8"	25	\$ 620.75
10"	41	\$ 908.63
12"	46	\$ 1,030.08



The 2 Bolt Coupling Working Range

Nominal Size	Overall Range	Inner Gasket Range	Outer Gasket Range
4"	4.46 - 5.63	4.46 - 5.03	4.97 - 5.63
6"	6.56 - 7.63	6.56 - 7.13	7.07 - 7.63
8"	8.54 - 9.84	8.54 - 9.17	9.13 - 9.84
10"	10.70 - 11.90	10.70 - 11.30	11.25 - 11.90
10"OS	11.00 - 12.25	11.00 - 11.65	11.60 - 12.25
12"	12.70 - 13.80	12.70 - 13.30	13.25 - 13.80
12"OS	13.15 - 14.40	13.15 - 13.80	13.75 - 14.40

Note: 4" - 8" 305 PSI Working Pressure
10" & 12" 200 PSI Working Pressure

Angular Deflection up to 7

Bolt Torque limit for 5/8" bolts is 80 ft./lbs.

All gaskets are NBR

A torque wrench should be used to ensure that the gaskets are sufficiently compressed

The use of a pipe insert is required when using on HDPE

Coupling is fully assembled with both gaskets when shipped

Couplings do not prevent Pipe Pullout. Restraint should be used where required

ROBAR INDUSTRIES LTD.

BC Phone (604) 591-8811 / 1-800-663-6553

Fax (604) 591-5288

Email: waterworks@robarindustries.com

LES PRODUITS INDUSTRIELS ROBAR INC.

QUEBEC

Phone (450) 441-7525 / 1-800-315-9525

Fax (450) 441-4894

Web: www.robarindustries.com



The VANTAGE COUPLING

1498/1496/1598/1596/1696

PRICING INFORMATION

MULTI-RANGE COUPLINGS

Nominal Size	Weight Lbs.	LIST PRICE			
		1498	1496	1598	1596
		Shop Coat MS Bolts & Nuts	Shop Coat SS Bolts & Nuts	Epoxy Coated MS Bolts & Nuts	Epoxy Coated SS Bolts & Nuts
4"	25	\$ 226.35	\$ 260.40	\$ 253.72	\$ 296.78
6"	32	\$ 297.79	\$ 329.83	\$ 325.83	\$ 360.88
8"	41	\$ 351.19	\$ 380.59	\$ 380.59	\$ 434.66
10"	75	\$ 514.11	\$ 561.53	\$ 554.17	\$ 621.61
12"	107	\$ 661.69	\$ 717.76	\$ 768.50	\$ 821.57

Nominal Size	Weight Lbs.	LIST PRICE
		1696
		All Stainless Steel
4"	25	\$ 551.70
6"	32	\$ 748.46
8"	41	\$ 1,103.76
10"	75	\$ 1,599.26
12"	107	\$ 1,883.30

The Vantage Working Range	Barrel Length	# of Bolts	
4"	4.50 - 5.60	8"	3
6"	6.63 - 7.60	8"	3
8"	8.63 - 9.80	8"	3
10"	10.75 - 12.26	12"	4
12"	12.75 - 14.40	12"	5

Note: 150 PSI Working Pressure
 Angular Deflection up to 7 degrees
 Bolt Torque limit for 5/8" bolts is 70 ft./lbs.
 All gaskets are SBR
 A torque wrench should be used to ensure that the gaskets are sufficiently compressed
Couplings do not prevent Pipe Pullout. Restraint should be used where required

ROBAR INDUSTRIES LTD.

BC Phone (604) 591-8811 / 1-800-663-6553
 Fax (604) 591-5288
 Email: waterworks@robarindustries.com

LES PRODUITS INDUSTRIELS ROBAR INC.

QUEBEC Phone (450) 441-7525 / 1-800-315-9525
 Fax (450) 441-4894
 Web www.Robarindustries.com

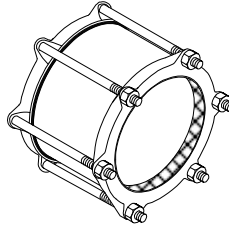

Nominal Size	Weight Lbs	LIST PRICE					
		1408	1406	1506	1508	1519	1507
4" STD	16.0	\$ 118.92	\$ 170.10	\$ 212.47	\$ 160.87	\$ 185.14	\$ 241.14
4" LB	21.0	\$ 136.75	\$ 195.61	\$ 244.21	\$ 184.99	\$ 211.93	\$ 279.71
6"STD	24.0	\$ 171.24	\$ 234.90	\$ 301.41	\$ 223.82	\$ 265.84	\$ 337.27
6"LB	32.0	\$ 196.94	\$ 270.12	\$ 346.63	\$ 257.39	\$ 304.80	\$ 391.24
8"STD	28.0	\$ 218.79	\$ 294.91	\$ 378.27	\$ 282.60	\$ 341.28	\$ 421.26
8"LB	34.0	\$ 251.61	\$ 339.15	\$ 435.03	\$ 324.98	\$ 392.62	\$ 488.66
10"	49.0	\$ 334.30	\$ 426.50	\$ 534.48	\$ 413.53	\$ 479.29	\$ 581.45
12"	56.0	\$ 397.63	\$ 510.22	\$ 632.43	\$ 514.40	\$ 564.29	\$ 689.70

STD= 5" center barrel

LB = 7" center barrel

The Stab Fit Working Range		# of Bolts	Barrel Length
4"	4.50 - 5.10"	4	5" or 7"
6"	6.63 - 7.22"	4	5" or 7"
8"	8.63 - 9.30"	5	5" or 7"
10"	10.75 - 11.40"	7	7"
12"	12.75 - 13.50"	7	7"

Notes: Couplings fits IPS OD to old cast OD with one gasket
 Does not require dis-assembly to install
 One less bolt compared to conventional bolted coupling
 An economical alternative to typical wide range couplings
 Rugged cast ductile construction

Couplings do not prevent Pipe Pullout. Restraint should be used where required

ROBAR INDUSTRIES LTD.

BC Phone (604) 591-8811 / 1-800-663-6553
 Fax (604) 591-5288
 Email: waterworks@robarindustries.com

LES PRODUITS INDUSTRIELS ROBAR INC.

QUEBEC Phone (450) 441-7525 / 1-800-315-9525
 Fax (450) 441-4894
 Web: www.Robarindustries.com



EBAA 3800 SERIES COUPLINGS

PRICING INFORMATION

The 3800 Restrained Coupling is used for joining and restraining two plain end pipes of the same or dissimilar materials (Ductile Iron, Steel, PVC C900, and HDPE).

EBAA 3800 Restrained Coupling

Nominal Size	Weight Lbs.	LIST PRICE		
		STD x STD (C900 or DI Pipe)	List Add on per* Transition Gasket	List Add on for SS Tie Rods
4"	37	\$ 324.68	\$ 14.87	\$ 114.97
6"	50	\$ 436.55	\$ 18.88	\$ 173.37
8"	68	\$ 566.75	\$ 26.95	\$ 173.37
10"	86	\$ 751.80	\$ 41.66	\$ 229.93
12"	104	\$ 858.87	\$ 52.93	\$ 229.93

*Transition gasket is required for use on IPS pipe Steel or HDPE)
For larger sizes please contact Robar

Note: *Up to 250 PSI Working Pressure*
The use of a pipe wall stiffening insert (model 9626) is required for use on HDPE
Angular Deflection up to 5 degrees
3/4" Diameter Tie Rods
Torque limiting twist off nuts
All gaskets are SBR. Other compounds available
Couplings are made of cast ductile iron
Minimum 2 to 1 safety factor

ROBAR INDUSTRIES LTD.

BC Phone (604) 591-8811 / 1-800-663-6553
 Fax (604) 591-5288
 Email: waterworks@robarindustries.com

LES PRODUITS INDUSTRIELS ROBAR INC.

QUEBEC Phone (450) 441-7525 / 1-800-315-9525
 Fax (450) 441-4894
 Web: www.Robarindustries.com



1180 ISOLATING BOOTS

PRICE INFORMATION

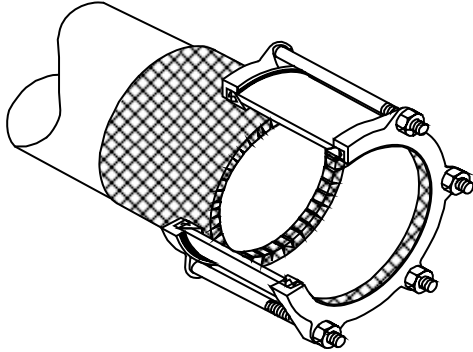
**Standard Sizes:**

4" to 24" Nominal Pipe OD
Larger Sizes are available

USE:

Robar 1180 Isolating boots are used in conjunction with ROBAR couplings to separate pipe ends in cathodically protected areas.

Gasket length is 7"

Material Specification:

Boot: NBR (Buna N) Rubber Compound for water service and high dielectric value. (ASTM D2000-80 AA 615).

Nominal Pipe Size		LIST PRICE
4		\$ 39.61
6		\$ 53.00
8		\$ 63.81
10		\$ 95.61
12		\$ 106.90
14		\$ 122.37
16		\$ 140.82
18		\$ 153.45
20		\$ 171.65
22		\$ 192.01
24		\$ 204.61

ROBAR INDUSTRIES LTD.

BC Phone (604) 591-8811 / 1-800-663-6553
Fax (604) 591-5288
Email: waterworks@robarindustries.com

LES PRODUITS INDUSTRIELS ROBAR INC.

QUEBEC Phone (450) 441-7525 / 1-800-315-9525
Fax (450) 441-4894
Web: www.Robarindustries.com



1410 & 1510 COUPLING END CAPS

PRICE INFORMATION

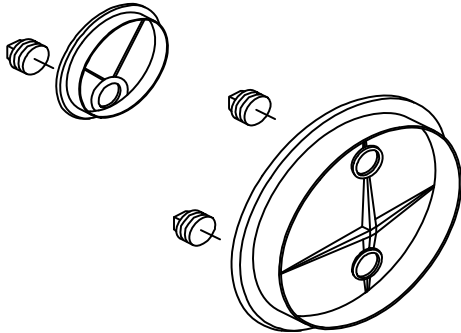

Standard Sizes:

4" to 12" Nominal Pipe OD

USE:

Robar 1410 & 1510 End Caps are used in conjunction with a standard ROBAR coupling (ordered separately) for the purpose of: Temporary stops for mains to be extended in the future

MATERIAL SPECIFICATION

CAP: Cast Ductile Iron (ASTM A536)
 PLUG: Cast Iron - 2"IP square head
 COATING: 1410 - two coats of Enamel
 1510 - Corrosion Protective Epoxy Coated (AWWA C-213).

For an enamel coated 8" End Cap, the ordering code is:
1410 - 8"

Nominal Pipe Size	Cap OD	Outlet Plug Quantity	LIST PRICE	
			1410	1510
4	5.1	1	\$ 68.72	\$ 85.27
6	7.1	1	\$ 76.95	\$ 94.36
8	9.3	1	\$ 103.03	\$ 124.45
10	11.4	2	\$ 154.25	\$ 185.91
12	13.6	2	\$ 198.22	\$ 236.47

Note: End capped coupling must be restrained to resist hydraulic end thrust

ROBAR INDUSTRIES LTD.

BC Phone (604) 591-8811 / 1-800-663-6553
 Fax (604) 591-5288
 Email: waterworks@robarindustries.com

LES PRODUITS INDUSTRIELS ROBAR INC.

QUEBEC Phone (450) 441-7525 / 1-800-315-9525
 Fax (450) 441-4894
 Web: www.Robarindustries.com



1606 STAINLESS STEEL COUPLINGS

PRICE INFORMATION

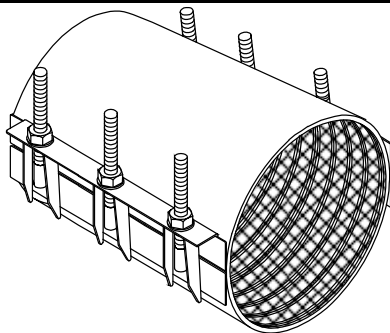

Nominal Pipe Size	Maximum Pressure (PSI)	LIST PRICE				
		Style 1 6" Shell	Style 1 12" Shell	Style 2 12" Shell	Style 3 18" Shell	Style 3 24" Shell
4	150	\$ 134.77	\$ 244.38	\$ 393.58		
6	150	\$ 146.99	\$ 267.98	\$ 427.27		
8	150	\$ 173.05	\$ 287.28	\$ 455.48		
10	150		\$ 310.76	\$ 482.30		
12	150		\$ 353.08	\$ 513.38		
14	125		\$ 401.06	\$ 546.07		
16	100				\$ 1,090.96	\$ 1,385.10
18	100				\$ 1,148.81	\$ 1,455.66
20	100					\$ 1,620.60
22	100					\$ 1,674.43
24	100					\$ 1,731.85

Note: Other sizes and pressure ratings available
 Bolt torque limit for all sizes is 80 ft/lbs
 ROBAR 9626 Adjustable stainless steel Inserts are recommended for use on HDPE
 4.80"OD is the minimum OD 1606 Couplings can be sized to fit

ROBAR INDUSTRIES LTD.

BC Phone (604) 591-8811 / 1-800-663-6553
 Fax (604) 591-5288
 Email waterworks@robarindustries.com

LES PRODUITS INDUSTRIELS ROBAR INC.

QUEBEC Phone (450) 441-7525 / 1-800-315-9525
 Fax (450) 441-4894
 Web: www.Robarindustries.com



1200 Series Galvanized Couplings

PRICE INFORMATION



Nominal Pipe Size	Actual Pipe OD	Maximum Pressure (PSI)	LIST PRICE		
			QTY 1 - 49	QTY 50 - 149	QTY 150 +
1/2"	.84"	150	\$ 16.22	\$ 14.75	\$ 13.28
3/4"	1.05"	150	\$ 19.22	\$ 17.47	\$ 15.72
1"	1.32"	150	\$ 24.21	\$ 22.02	\$ 19.82
1-1/4"	1.66"	150	\$ 31.60	\$ 28.72	\$ 25.85
1-1/2"	1.90"	150	\$ 38.42	\$ 34.91	\$ 31.43
2"	2.38"	150	\$ 47.98	\$ 43.61	\$ 39.24

Note: Gaskets are made from Nitrile Rubber (NBR) compound.
Galvanized finish for corrosion resistance
non-restrained connection between pipes of the same diameter

ROBAR INDUSTRIES LTD.

BC Phone (604) 591-8811 / 1-800-663-6553
Fax (604) 591-5288
Email: waterworks@robarindustries.com

LES PRODUITS INDUSTRIELS ROBAR INC.

QUEBEC Phone (450) 441-7525 / 1-800-315-9525
Fax (450) 441-4894
Web www.Robarindustries.com

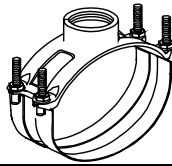

2406 & 2408 SERVICE SADDLES

CAST DUCTILE IRON

PRICE INFORMATION

2406 SADDLES COMPLETE WITH FLAT WASHERS

2406 - Designed for tapping into Steel, Ductile, Cast Iron, C900 and AC pipe

Nominal Pipe Size	Working Range		Outlet Sizes AWWA CC or IP	Approximate Shipping Weights		List Price Saddle Body		List Price *Strap Kit	List Price Saddle	
	Low	High*		(LBS.)	(KG)	Single (SS)	Double (DS)		(SS)	(DS)
2"	2.23	2.56	3/4 - 1	2.0	0.9	\$ 29.97		\$20.98	\$57.05	
3"	3.25	3.54	3/4 - 1	2.5	1.1	\$ 31.17		\$22.18	\$58.05	
4"	4.5	5.4	3/4 - 2	5.0	2.3	\$ 32.40		\$25.05	\$59.63	
				6.5	2.9		\$ 41.15			\$ 95.53
6"	6.62	7.5	3/4 - 2	6.0	2.7	\$ 33.20		\$28.15	\$63.59	
				8.5	3.9		\$ 42.56			\$ 100.32
8"	8.62	9.62	3/4 - 2	6.5	2.9	\$ 41.98		\$31.25	\$76.12	
				10.0	4.5		\$ 44.71			\$ 110.28
10"	10.75	12.12	3/4 - 2	7.5	3.4	\$ 46.28		\$37.76	\$87.21	
				11.5	5.2		\$ 47.51			\$ 126.26
12"	12.75	14.38	3/4 - 2	11.5	5.2	\$ 48.76		\$42.30	\$94.30	
				12.5	5.7		\$ 61.14			\$ 149.80
14"	15.15	16.00	3/4 - 2	15.0	6.8		\$ 103.23	\$43.35		\$ 186.95
16"	17.25	17.80	3/4 - 2	19.0	8.6		\$ 113.36	\$49.88		\$213.13
	17.80	18.00								

2408 SADDLES COMPLETE WITH FLAT WASHERS

2408 - Designed for tapping into Steel, Ductile and Cast Iron pipe. Not suitable on plastic pipe

Nominal Pipe Size	Working Range		Outlet Sizes AWWA CC or IP	Approximate Shipping Weights		List Price Saddle Body		List Price *Strap Kit	List Price Saddle	
	Low	High*		(LBS.)	(KG)	Single (SS)	Double (DS)		(SS)	(DS)
4"	4.5	5.4	3/4 - 2	5.0	2.3	\$ 32.40		\$15.30	\$50.56	
				6.5	2.9		\$ 41.15			\$ 76.94
6"	6.62	7.5	3/4 - 2	6.0	2.7	\$ 33.20		\$21.37	\$57.47	
				8.5	3.9		\$ 42.56			\$ 87.54
8"	8.62	9.62	3/4 - 2	6.5	2.9	\$ 41.98		\$22.57	\$68.25	
				10.0	4.5		\$ 44.71			\$ 93.79
10"	10.75	12.12	3/4 - 2	7.5	3.4	\$ 46.28		\$25.47	\$75.80	
				11.5	5.2		\$ 47.51			\$ 102.49
12"	12.75	14.38	3/4 - 2	11.5	5.2	\$ 48.76		\$27.18	\$80.20	
				12.5	5.7		\$ 61.14			\$ 120.86
14"	15.15	16.00	3/4 - 2	15.0	6.8		\$ 103.23	\$28.00		\$ 151.66
16"	17.25	17.80	3/4 - 2	19.0	8.6		\$ 113.36	\$28.06		\$178.33
	17.80	18.00								

* STRAP KIT consist of 1x Strap, 2x Nuts, 2x Washers

ROBAR INDUSTRIES LTD.

BC Phone (604) 591-8811 / 1-800-663-6553
 Fax (604) 591-5288
 Email: waterworks@robarindustries.com

LES PRODUITS INDUSTRIELS ROBAR INC.

QUEBEC Phone (450) 441-7525 / 1-800-315-9525
 Fax (450) 441-4894
 Web www.Robarindustries.com